

**SD750**

# **ACCESSORIES MANUAL**

**PROFIBUS BOARD**



LOW VOLTAGE VARIABLE SPEED DRIVE



# **SD750**

— *LOW VOLTAGE VARIABLE SPEED DRIVE* —

## **Accessories Manual** Profibus board

**Edition: July 2021**  
SD75MA06BI Rev. B

## ABOUT THIS MANUAL

### PURPOSE

This manual contains important instructions for the installation, configuration and use of the **Profibus** optional board for Power Electronics' SD750 variable speed drives.

### TARGET AUDIENCE

This manual is intended for qualified customers who will install, operate and maintain Power Electronics SD750 variable speed drives.

Only trained electricians may install and commission the drives.

### REFERENCE MANUALS

The following reference documents are available for SD750 variable speed drives:

- Hardware and Installation Manual.
- Programming and Software Manual.
- Maintenance Manual.
- Pumps Application Manual.

### POWER ELECTRONICS CONTACT INFORMATION

Power Electronics USA Inc.  
1510 N. Hobson Street, Gilbert,  
Phoenix  
AZ 85233

UNITED STATES OF AMERICA  
US Sales: 602-354-4890 / (480) 519-5977

Power Electronics España, S.L.  
Polígono Industrial Carrases  
Ronda del Camp d'Aviació nº 4  
46160, Llíria (Valencia)  
SPAIN

Fax: (+34) 96 131 82 01  
Website: [www.power-electronics.com](http://www.power-electronics.com)

REVISIONS CONTROL		
DATE (DD/MM/YYYY)	REVISION	DESCRIPTION
06/03/2020	A	First Edition.
01/07/2021	B	Commissioning. Faults and warnings mapping. Misprints corrections.

---

The equipment and technical documentation are periodically updated. Power Electronics reserves the right to modify all or part of the contents of this manual without previous notice. To consult the most updated information of this product, you may access our website [www.power-electronics.com](http://www.power-electronics.com), where the latest version of this manual can be downloaded. The reproduction or distribution of the present manual is strictly forbidden, unless express authorization from Power Electronics.



# TABLE OF CONTENTS

<b>ABOUT THIS MANUAL .....</b>	<b>2</b>
<b>SAFETY SYMBOLS .....</b>	<b>5</b>
<b>SAFETY INSTRUCTIONS .....</b>	<b>6</b>
<b>1. INTRODUCTION .....</b>	<b>7</b>
Profibus board specifications .....	8
LED Indicator .....	9
<b>2. CONNECTION TO THE DRIVE .....</b>	<b>10</b>
Connectors Description .....	11
Connection Scheme .....	11
<b>3. COMMISSIONING .....</b>	<b>12</b>
Parameters setting .....	15
Modbus Addresses .....	18
<b>4. FAULTS AND WARNINGS MAPPING .....</b>	<b>20</b>
Description of Fault List .....	20
Troubleshooting .....	20
List of Warning Messages .....	20





## SAFETY SYMBOLS

Always follow safety instructions to prevent accidents and potential hazards from occurring.

In this manual, safety messages are classified as follows:

	<b>WARNING</b>	<p>Identifies potentially hazardous situations where dangerous voltage may be present, which if not avoided, could result in minor personal injury, serious injury or death.</p> <p>Be extremely careful and follow the instructions to avoid the risk of electrical shocks.</p>
	<b>CAUTION</b>	<p>Identifies potentially hazardous situations, which if not avoided, could result in product damage, or minor or moderate personal injury.</p> <p>Read the message and follow the instructions carefully.</p>
	<b>NOTICE</b>	<p>Identifies important measures to take in order to prevent damage equipment and warranty lost, as well as encouraging good use and environmental practices.</p>

Other symbols used in this manual for safety messages are the following:

	Hot surface. Be careful and follow the instructions to avoid burns and personal injuries.
	Risk of fire. Be careful and follow the instructions to prevent causing an unintentional fire.
	Caution, risk of electric shock. Energy storage timed discharge. Wait for the indicated time to avoid electrical hazards.
	Caution, risk of hearing damage. Wear hearing protection.

# SAFETY INSTRUCTIONS

## IMPORTANT!

Read carefully this manual to maximize the performance of the product and to ensure its safe installation and use.

In order to appropriately use the drive, please, follow all instructions described in the *Hardware and Installation Manual* which refer to transportation, installation, electrical connection and commissioning of the equipment.

For maintenance operations, follow the instructions from the *Maintenance Manual*.

Power Electronics accepts no responsibility for any damages resulting from incorrect use of equipment.



## CAUTION

---

Read carefully the *Hardware and Installation Manual*, the *Maintenance Manual* and all documentation related to the drive to guarantee its safe use and avoid the risk of personal injuries and damages to the equipment.

---

Ensure compliance with local and national regulations of the installation site.

---



# INTRODUCTION

# 1

SD750 drives are compatible with several optional boards:

- Communication boards (Ethernet/IP, Profinet, CANopen, Profibus...).
- Encoder board.
- Digital and analog I/O expansion boards.
- Optical fiber board

...among others. Up to three optional boards can be connected, maximum two of the same type.

**This manual focuses on the optional Profibus expansion board.** This board allows the equipment to be integrated into Profibus communication network in a comfortable and simple way.

It has been designed to provide information about its operational status at any time.

Below is the front of the Profibus expansion board:



EN

## Profibus board specifications

The Profibus expansion board specifications are detailed below:

### Interface

- Profibus connector - DP D-SUB 9 pins.

### Interface Profibus-DP

- Profibus - DP interface.
- Transmission speed auto-detected up to 12Mb.
- Diagnostic data length of 13 Bytes (maximum).
- Data length for 176 Byte Configuration (maximum).
- Configuration data length of 8 Bytes (maximum).
- Polling length of 120 Bytes (maximum).
- GSD file PE\_SD750.GSD.

### GSD File

The GSD file contains information about the Profibus communication module installed in the equipment. When the Profibus network is configured, its software configuration requires a GSD file.

\*\* To download the file, please contact Power Electronics.

## LED Indicator

The profibus expansion board has one led indicator on the top of the board, which provides information about the status. Note that the led is bi-color and will change its color and frequency according to the situation.

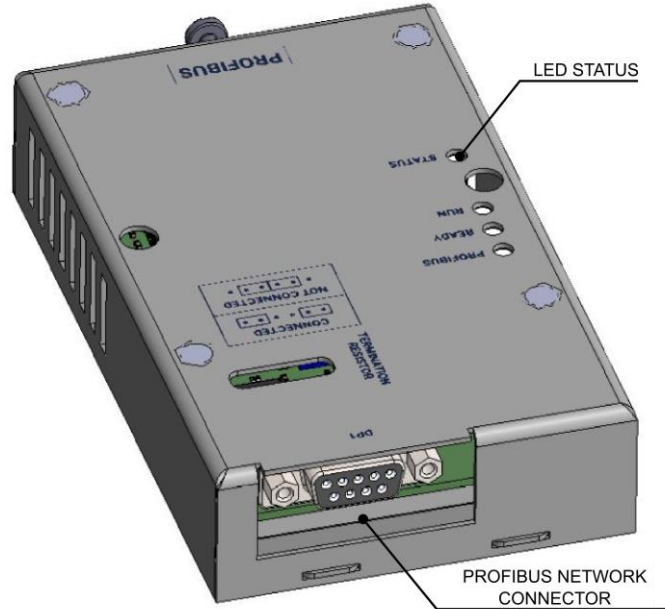

SD75DTR008AI

Refer to the following table for the description of all the possible colors and frequencies of the led indicator, as well as what they represent.

LED	COLOR / FREQUENCY	DESCRIPTION
STATUS	Red, steady	Hardware failure or inability to install the protocol. The board probably has to be repaired.
	Red, slow flashing	The board cannot establish communication with the network controller or initialize the protocol.
	Red, fast flashing	The board cannot establish communication with the SD750 central board.
	Green, slow flashing	The system is operating correctly. <sup>1</sup>
	Green, fast flashing	Test mode. User has set the board to test mode.

<sup>1</sup> When it is indicated that the system works correctly, it means that the communication of the Profibus board with the integrated communication chip and with the central micro of the SD750 is correct. This does not mean, however, that communication with the PLC is correct.

## CONNECTION TO THE DRIVE

# 2

The Profibus expansion board connects directly, via the sixteen-pin ID connector on the back, to any of the three expansion connectors on the central control board of the SD750 drive. The Profibus expansion board allows to configure the SD750 as a slave to a PLC master using the Profibus industrial communication protocol. This communication allows to exchange information between both devices by configuring read and write variables.

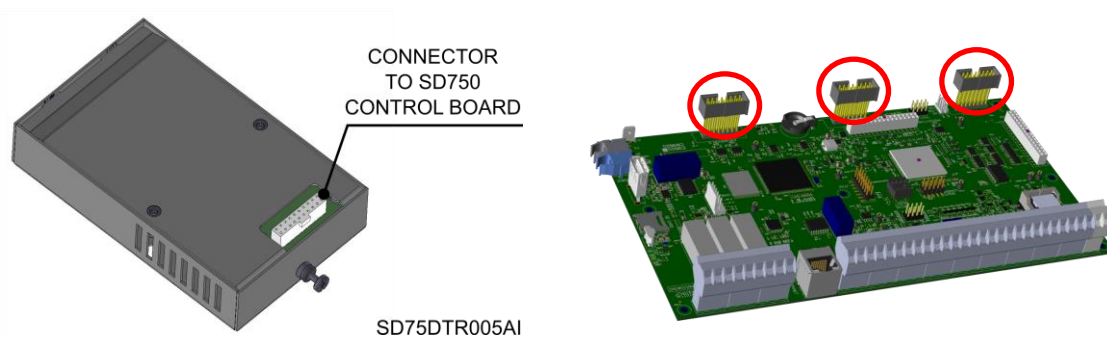

### CAUTION

**Power Electronics' SD750 drives operate with a high electric energy.**

Make sure the power has been turned off and wait at least 10 minutes to ensure that the DC bus has been discharged, make sure with a multimeter that there is no input, output or DC bus voltage before installing the expansion board. Otherwise, there is a risk of personal injury or accident.

## Connectors Description

The Profibus connection is made using a standard 9-pin SUB-D connector according to the definition of the EN 50170 standard. The wiring for the nine-pin connector is shown in the figure below:

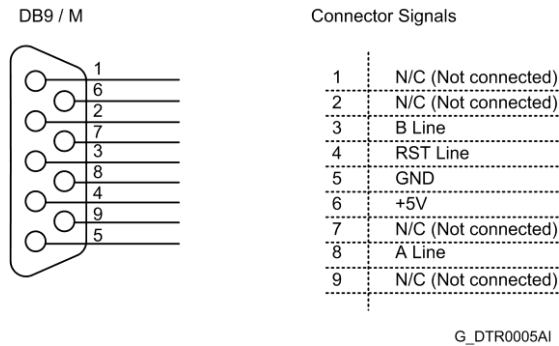

## Connection Scheme

The following image shows a detailed distribution of the components of the optional Profibus board:

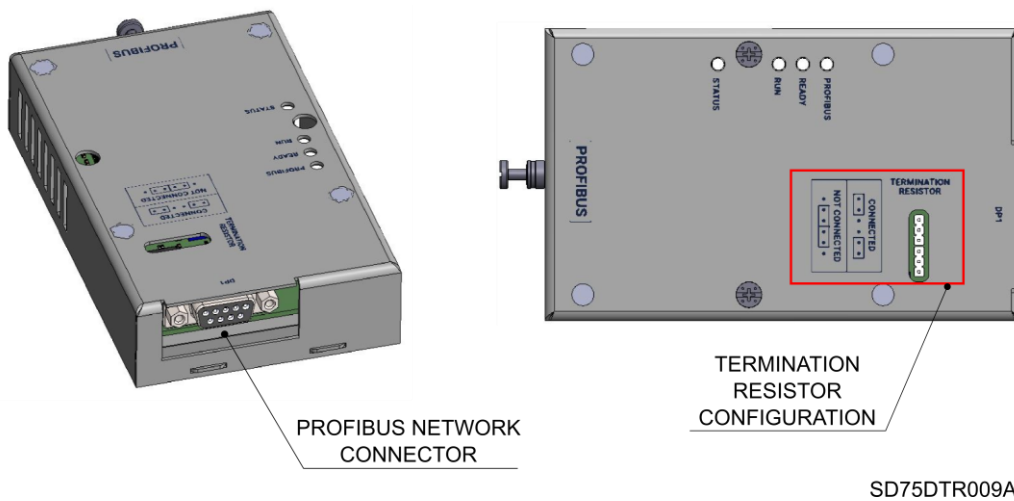

On the Profibus board there are two connectors used to connect the board to the SD750 drive. In addition, there is a connector (SUB-D / F 9-pin) that is used for connection to the Profibus network.

EN

# COMMISSIONING

## 3

Follow the next steps to carry out the commissioning of the Profibus board:

1. Load the GSD file into the PLC master.

Once the GSD file is loaded, which allows us to introduce the SD750 device into a Profibus network, the configuration from the PLC master will indicate to the system how many variables are going to be shared, both writing variables (from the PLC to the SD750) and reading variables (from SD750 to PLC). Depending on the GSD loaded, the number of inputs and outputs and the possibility to select the content of these variables will vary. There are five different types of configuration of inputs and outputs:

Type 1		
Inputs and Outputs	Type	
5 inputs	Selectable	Read and write
5 outputs	Selectable	Read and write

Type 2		
Inputs and Outputs	Type	
10 inputs	Selectable	Read and write
10 outputs	Selectable	Read and write

Type 3		
Inputs and Outputs	Type	
20 inputs	Selectable	Read and write
20 outputs	Selectable	Read and write

Type 4		
Inputs and Outputs	Screen	Value
Input 1	Status Comms	3584
Input 2	Motor Speed (%)	2002
Input 3	Motor Current	2006
Input 4	Motor Power	2009
Input 5	Motor Torque	2007
Input 6	Motor Frequency	2004
Output 1	Host Start Control	3585
Output 2	Host Comms Control (Ref)	3569

Type 5		
Inputs and Outputs	Screen	Value
Input 1	Status Comms	3584
Input 2	Motor Speed (%)	2002
Input 3	Motor Current	2006
Input 4	Motor Power	2009
Input 5	Motor Torque	2007
Input 6	Motor Frequency	2004
Input 7	Motor Voltage	2005
Input 8	Motor phi cosine	2008
Input 9	DC bus Voltage	2034
Input 10	Speed Reference	2000
Input 11	Drive temperature	2038
Input 12	IGBT Temperature	2039
Input 13	Digital Input status	2080
Input 14	Output Relays status	2081
Input 15	AI 1 percentage (%)	2061
Input 16	AI 2 percentage (%)	2064
Output 1	Host Start Control	3585
Output 2	Host Comms Control (Ref)	3569
Output 3	Host Reset Control	3587
Output 4	Host Trip Control	3588

EN

2. Configure network parameters (G21, see section "[Parameters setting](#)") so they match with the data expected by the master.
3. Configure the Profibus slave on the PLC master (network configuration and number of shared variables).
4. Configure the Profibus slave on the SD750 (network and Custom Modbus configuration associated with the shared variables).
5. Connect the Profibus board and check its status and communication.
6. Verify communication is established. Configure action in case of communication faults with the master.
7. Connect communication wiring and ensure communication with the SD750 is correct (G23.3). Configure action in case of communication fault.

Once the slave has been configured correctly, both in the PLC and in the SD750 itself, the connection may be made, and the configured variables will be shared.

The rest of the commissioning depends on the PLC, the program used, etc.



## Parameters setting

The parameters that are activated once the board is connected are summarized below:

### NOTICE

For more details about the Modbus address and value range, see the SD750 Drive Programming and Software Manual.

## Subgroup 20.2: Profibus

The G20.2 group corresponds to the Profibus configuration parameters:

### NOTICE

These parameters must match the configuration of the PLC.

#### Subgroup 20.2.1: Master inputs

Shows the number of master inputs, which matches the configuration of the PLC.

Screen	Range	Function	Set on RUN
G20.2.1.1-Protocol N Master Inputs	0 to 20	Defines the number of inputs (N) for the Profibus protocol. The registers of the drive are mapped onto these generic registers. <b>Note:</b> This parameter is read only type.	YES
G20.2.1.2-Protocol N Master Input 1 Add = 0	0 to 65535	These parameters store the information of the variables corresponding to the inputs of the PLC master. These inputs are mapped into the consecutive registers of the Modbus configurable mirrors.  The number of G20.2.1.x parameters shown depends on the number of inputs (N) defined in G20.2.1.1.	YES
G20.2.1.3 Protocol N Master Input 2 Add = 0			
...			
G20.2.1.21 Protocol N Master Input 20 Add = 0			

#### Subgroup 20.2.2: Master Outputs

Shows the number of master outputs, which matches the configuration of the PLC.

Screen	Range	Function	Set on RUN
G20.2.2.1-Protocol N Master Outputs	0 to 20	Defines the number of outputs (N) for the Profibus protocol. The registers of the drive are mapped onto these generic registers. <b>Note:</b> This parameter is read only type.	YES
G20.2.2.2-Protocol N Master Output 1 Add = 0	0 to 65535	These parameters store the information of the variables corresponding to the outputs of the PLC master. These outputs are mapped into the consecutive registers of the Modbus configurable mirrors.  The number of G20.2.2.x parameters shown depends on the number of outputs (N) defined in G20.2.2.1.	YES
G20.2.2.3-Protocol N Master Output 2 Add = 0			
...			
G20.2.2.21-Protocol N Master Output 20 Add = 0			

## Other subgroups

Screen	Range	Function	Set on RUN						
G20.2.3 – Profibus node address = 1	0 to 126	This parameter allows setting the slave ID address.	YES						
G20.2.4 – Connector Fault Mode = Fault	0 to 1	<p>This parameter allows configuring the fault mode of the connector when communication with the master is not allowed.</p> <table border="1"> <thead> <tr> <th>OPT.</th> <th>FUNCTION</th> </tr> </thead> <tbody> <tr> <td>Fault</td> <td>The drive will trigger fault <i>F113: Lost PBUS c1 comms</i> when communication is not enabled.</td> </tr> <tr> <td>Ignore</td> <td>The fault is ignored, and it is not triggered.</td> </tr> </tbody> </table> <p><b>Note:</b> The status of the connector shows if the communication with another device is correct. In case of incorrect communication, the user can select whether a fault appears or is ignored.</p>	OPT.	FUNCTION	Fault	The drive will trigger fault <i>F113: Lost PBUS c1 comms</i> when communication is not enabled.	Ignore	The fault is ignored, and it is not triggered.	YES
OPT.	FUNCTION								
Fault	The drive will trigger fault <i>F113: Lost PBUS c1 comms</i> when communication is not enabled.								
Ignore	The fault is ignored, and it is not triggered.								
G20.2.5 – Connector State = Off	0 to 1	This parameter shows the state of the connector.	YES						

 **NOTICE**

From version 6.0.0 of the SD750 and 2.0.0 of the Coin Profibus, these variables will have a default value belonging to the most probable configuration in the field. It is only necessary to define those input and output variables that have been configured in the master PLC.

## Subgroup 20.6: Custom Modbus configuration

Screen	Range	Function	Set on RUN
G20.6.1 Custom modbus addr 1 = 0	0 to 65535	<p>These parameters allow configuring 120 consecutive registers (4500 to 4619) variables from the Modbus map as required. This is particularly useful when designing a SCADA, so that the client can consult several registers in a single reading operation.</p> <p>They are grouped as follows:</p> <ul style="list-style-type: none"> <li>• Subgroup 20.6.1: Values 1 to 30</li> <li>• Subgroup 20.6.2: Values 31 to 60</li> <li>• Subgroup 20.6.3: Values 61 to 90</li> <li>• Subgroup 20.6.4: Values 91 to 120</li> </ul>	YES
G20.6.2 Custom modbus addr 2 = 0		<p>In parameters G20.6.x, user must enter the Modbus registers (Modbus address – 40001) that will be pointed to. Once configured, parameters G20.7.x can be used to read or write the value of each register.</p> <p><b>Example:</b> Let us suppose we want to store the local speed reference (G3.3, Modbus 40053). We must configure register 52 (40053 – 1) in G20.6.1, at <i>Custom modbus addr1</i>. Then, in G20.7.1, <i>Custom modbus val 1</i> we will read the current value of the local speed reference. To modify it, we must enter the new value and save changes.</p> <p><b>Note:</b> When reading or writing a variable, keep in mind the type of variable and its Modbus range to ensure values are interpreted correctly.</p>	
...			
G20.6.120 Custom modbus addr 120 = 0			

### Subgroup 20.7: Custom Modbus values

Screen	Range	Function	Set on RUN
G20.7.1 Custom modbus val1 = 0	0 to 65535	These parameters can be used to read and write the values of the registers that were previously configured in G20.6. They are grouped as follows: <ul style="list-style-type: none"> <li>• Subgroup 20.7.1: Values 1 to 30</li> <li>• Subgroup 20.7.2: Values 31 to 60</li> <li>• Subgroup 20.7.3: Values 61 to 90</li> <li>• Subgroup 20.7.4: Values 91 to 120</li> </ul> <b>Note:</b> When reading or writing a variable, keep in mind the type of variable and its Modbus range to ensure values are interpreted correctly.	YES
G20.7.2 Custom modbus val2 = 0			
...			
G20.7.120 Custom modbus val30 = 0			

### Subgroup 23.3: Communications

The G23.3 group allows to view the status of communication expansion boards.

Screen	Range	Function	Set on RUN								
G23.3.7 Profibus board status = Off	Off On	Shows the status of the Profibus board. <table border="1" style="margin-top: 10px;"> <thead> <tr> <th>OPT.</th> <th>FUNCTION</th> </tr> </thead> <tbody> <tr> <td>Off</td> <td>The board is not connected.</td> </tr> <tr> <td>On</td> <td>The board is connected</td> </tr> </tbody> </table>	OPT.	FUNCTION	Off	The board is not connected.	On	The board is connected	NO		
OPT.	FUNCTION										
Off	The board is not connected.										
On	The board is connected										
G23.3.8 Profibus board test = No	No Yes	Enables the LED fast blinking. This is useful to locate the board in case several boards of the same type are connected. <b>Note:</b> This parameter will only appear if a Profibus board has been connected.	NO								
G23.3.9 Profibus Com Error = Fault	Off Warning Fault	Allows defining the behavior of the drive in case communication with the Profibus board is lost. <table border="1" style="margin-top: 10px;"> <thead> <tr> <th>OPT.</th> <th>FUNCTION</th> </tr> </thead> <tbody> <tr> <td>Off</td> <td>Drive will remain operating normally.</td> </tr> <tr> <td>Warning</td> <td>Warning "W37: Profibus expansion" expansion will be triggered.</td> </tr> <tr> <td>Fault</td> <td>Fault "F72: Expansion Profibus comm" will be triggered and the drive will stop.</td> </tr> </tbody> </table>	OPT.	FUNCTION	Off	Drive will remain operating normally.	Warning	Warning "W37: Profibus expansion" expansion will be triggered.	Fault	Fault "F72: Expansion Profibus comm" will be triggered and the drive will stop.	NO
OPT.	FUNCTION										
Off	Drive will remain operating normally.										
Warning	Warning "W37: Profibus expansion" expansion will be triggered.										
Fault	Fault "F72: Expansion Profibus comm" will be triggered and the drive will stop.										

#### NOTICE

The possible states of the parameters of the G23.3 group are detailed below:

- If G23.3.7 changes from Enabled to Disabled and G23.3.9 is Disabled nothing happens.
- If G23.3.7 changes from Enabled to Disabled and G23.3.9 indicates warning, W37 will appear: Expansion Profibus. If the communication is restored again, this warning disappears.
- If G23.3.7 changes from Enabled to Disabled and G23.3.9 indicates fault, F72 will appear: Com Ex Profibus.



## Modbus Addresses

### Configuration parameters

The configuration parameters for the Profibus board are summarized below:

Parameter	Screen	Address	Range	Modbus Range	Access [1]
G20.2.1.2 to G20.2.1.21	Protocol N Master Input 1 to 20	41031 to 41050	0 to 65535	0 to 65535	RO
G20.2.2.2 to G20.2.2.21	Protocol N Master Output 1 to 20	43261 to 43280	0 to 65535	0 to 65535	RO
G20.2.3	Profibus node address	40661	0 to 126	0 to 126	RW
G20.2.4	Connector Fault Mode	40665	Fault Ignore	0 to 1	RW
G20.2.5	Connector State	40666	Off On	0 to 1	RO
G20.6.1 to G20.6.120	Custom Modbus addresses 1 to 120	44601 to 44720	0 to 65535	0 to 65535	RW
G20.7.1 to G20.7.120	Values of custom Modbus registers 1 to 120	44801 to 44920	0 to 65535	0 to 65535	RW
G23.3.7	Profibus board status = Off	41027	Off On	0 to 1	RO
G23.3.8	Profibus board test = No	41028	No Yes	0 to 1	RW
G23.3.9	Profibus Com Error = Fault	41029	Off Warning Fault	0 to 2	RW

[1] **Access:** **RW:** Read and write. **RO:** Read only.

### Custom Modbus

Custom Modbus come by default as detailed in the tables below. **For more information on Modbus addresses, see the Software and Programming Manual for the SD750 drive.**

#### Master inputs

Position	Parameter	Modbus Address	Modbus Range
1	Status Comms	43585	Real Value = Modbus Value
2	Motor speed (%)	42003	Real Value = (Modbus Value / 100)
3	Motor current	42007	Real Value = (Modbus Value / 10)
4	Motor power	42010	Real Value = Modbus Value
5	Motor torque	42008	Real Value = (Modbus Value / 100)
6	Motor frequency	42005	Real Value = (Modbus Value / 10)
7	Motor voltage	42006	Real Value = Modbus Value
8	Motor phi cosine	42009	Real Value = (Modbus Value / 100)
9	DC bus voltage	42035	Real Value = Modbus Value
10	Speed reference	42001	Real Value = (Modbus Value / 100)
11	Drive temperature	42039	Real Value = Modbus Value
12	IGBT temperature	42040	Real Value = Modbus Value
13	L1-L2 supply voltage	42031	Real Value = Modbus Value
14	L2-L3 supply voltage	42032	Real Value = Modbus Value
15	AI1 percentage (%)	42062	Real Value = (Modbus Value / 100)
16	AI2 percentage (%)	42065	Real Value = (Modbus Value / 100)

**Master outputs**

Position	Parameter	Modbus Address	Modbus Range
1	Host Start Control	43586	Real Value = Modbus Value
2	Host Comms Control (Ref)	43570	Real Value = Modbus Value
3	Host Reset Control	43588	Real Value = Modbus Value
4	Host Trip Control	43589	Real Value = Modbus Value
5	Acceleration rate 1	40181	Real Value = (Modbus Value / 100)
6	Deceleration rate 1	40182	Real Value = (Modbus Value / 100)
7	Main start mode	40224	Real Value = Modbus Value
8	Main stop mode	40221	Real Value = Modbus Value
9	Minimum limit speed 1min	40401	Real Value = (Modbus Value / 100)
10	Maximum limit speed 1min	40402	Real Value = (Modbus Value / 100)
11	Speed ref 1 source	40051	Real Value = Modbus Value
12	Torque ref 1 source	40054	Real Value = Modbus Value
13	Main control mode	40071	Real Value = Modbus Value
14	Current limit	40405	Real Value = (Modbus Value / 10000)
15	Torque limit	40409	Real Value = (Modbus Value / 100)
16	Regeneration I limit	40417	Real Value = (Modbus Value / 10000)

EN

# FAULTS AND WARNINGS MAPPING

## 4

This section displays new faults and warnings that will only be available if Profibus expansion board is connected.

Please refer to the full list of faults and warnings in the SD750 drive Software and Programming Manual.

### Description of Fault List

DISPLAY	DESCRIPTION
<b>F72: Expansion Profibus comm</b>	Communication failure with the Profibus communication expansion board.
<b>F113: Lost PBUS c1 comms</b>	Failure in communication with the connector 1 of the Profibus board. <b>Note:</b> This fault will be triggered in case G20.2.5 = Disabled and G20.2.4 = Failure.
<b>F125: Profibus Exp Version</b>	The software version of the expansion board does not match the software version of the drive.

### Troubleshooting

DISPLAY	POSSIBLE CAUSE	ACTIONS
<b>F72: Expansion Profibus comm</b>	The communication between Profibus Master and Slave is cut off.	Revise the Profibus wiring and the configuration in the Master (PLC).
<b>F113: Lost PBUS c1 comms</b>	Communication with the connector 1 of the Profibus board is not correct.	Verify the board is connected correctly. Consult with Power Electronics.
<b>F125: Profibus Exp Version</b>	The version of software loaded in the expansion board does not match the current software version of the drive.	Contact Power Electronics.

### List of Warning Messages

Warning	Acronym	Name	Description
W37	EPB	Profibus expansion	There is a communications problem with the Profibus board.





**24H TECHNICAL ASSISTANCE 365 DAYS A YEAR**

FIND YOUR NEAREST DELEGATION  
**[POWER-ELECTRONICS.COM/CONTACT/](http://POWER-ELECTRONICS.COM/CONTACT/)**

**@ in   **