

SD250 Series

VARIABLE SPEED DRIVE



variable speed drive

Getting Started Manual

SD 250

Series

VARIABLE SPEED DRIVE

variable speed drive

Getting Started Manual

Edition: May 2009

SD25IM01GI Rev. G

SAFETY SYMBOLS

Always follow safety instructions to prevent accidents and potential hazards from occurring.

**WARNING**

This symbol means improper operation may result in serious personal injury or death.

**CAUTION**

Identifies shock hazards under certain conditions. Particular attention should be given because dangerous voltage may be present. Maintenance operation should be done by qualified personnel.



Identifies potential hazards under certain conditions. Read the message and follow the instructions carefully.



Identifies shock hazards under certain conditions. Particular attention should be given because dangerous voltage may be present.

Edition of May 2009

This publication could present technical imprecision or misprints. The information here included will be periodically modified and updated, and all those modifications will be incorporated in later editions.

To consult the most updated information of this product you might access through our website www.power-electronics.com where the latest version of this manual can be downloaded.

Revisions

Date	Revision	Description
01 / 03 / 2006	A	Updated software version SW UE 1.7
01 / 07 / 2006	B	Updated MODBUS communication
12 / 07 / 2006	C	Updated chapter OPTIONS
25 / 04 / 2007	D	Misprints update Update of chapters 4, 11.
08 / 01 / 2008	E	Misprints update
10 / 04 / 2008	F	Adaptation to new name SD250 Series
11 / 05 / 2009	G	Updated standard ratings. New Frames T5 and T6 Updated chapter OPTIONS Updated software version SW EU 2.x (up to 22kW)

INDEX

SAFETY INSTRUCTIONS	7
1. INTRODUCTION	12
1.1. Configuration table	12
1.2. Standard ratings.....	13
1.3. Drive description	14
2. INSTALLATION AND CONNECTION	15
2.1. Basic configuration.....	15
2.2. Environmental conditions	17
2.3. Power terminals wiring.....	19
2.4. Power supply and motor connection	29
2.5. Control terminals wiring.....	30
3. TECHNICAL CHARACTERISTICS	36
4. DIMENSIONS	38
4.1. Dimensions of Frame 1	38
4.2. Dimensions of Frame 2	39
4.3. Dimensions of Frame 3	40
4.4. Dimensions of Frame 4	41
4.5. Dimensions of Frame 5	42
4.6. Dimensions of Frame 6	43
5. POWER RANGE	44
6. CONFORMITY DECLARATION	45
7. PROGRAMMING KEYPAD	48
7.1. Parameters groups	48
7.2. Keypad/display characteristics	49
7.3. Alphanumerical displaying	51
7.4. Movement to different groups.....	52
7.5. Movement to different parameters of a group.....	55
7.6. Parameters setting	58
7.7. Operation status monitoring	63

8. PARAMETERS LIST	68
8.1. Drive group (DRV).....	68
8.2. Function 1 group (F).....	73
8.3. Function 2 group (H)	83
8.4. I/O group (I).....	98
9. FAULT MESSAGES	111
9.1. Displayed faults.....	111
9.2. Displayed faults remedy	114
9.3. Maintenance	118
10. RS485 COMMUNICATION	120
10.1. Introduction	120
10.2. Specifications.....	121
10.3. Installation.....	122
10.4. Communication protocol MODBUS-RTU.....	123
10.5. Address list	124
10.6. Faults solution.....	141
11. OPTIONS	142
11.1. Filters	142
11.2. Braking resistors	146
11.3. Conduit Box	147
11.4. Remote keypad / display unit	157
12. COMMONLY USED CONFIGURATIONS	160
12.1. Start/Stop commands by terminals and speed setting by analogue input	160
12.2. Start/Stop commands by keypad and speed setting by analogue input	164
12.3. Multi-speed commands (multi-step frequencies) using P6, P7 and P8 terminals.	168
12.4. Constant pressure control and automatic stop at zero level flow. Pressure command set by keypad.....	172
12.5. Automatic constant pressure control mode up to four reference frequencies and jog frequency as manual mode.....	176
12.6. Constant pressure control up to eight commands and automatic stop at zero level flow. No jog frequency function at manual mode	180
12.7. Speed control (up/down potentiometer) and Start/Stop commands by terminals.....	185
13. CONFIGURATION REGISTER	189

SAFETY INSTRUCTIONS

IMPORTANT!

- Safety instructions showed in this manual are useful to teach user how to use the product in a correct and safety way with the purpose of preventing possible personal injuries or property damages.
- Safety messages included here are classified as it follows:



WARNING

Do not remove the cover while the power is applied or the unit is in operation.

Otherwise, electric shock could occur.

Do not run the inverter with the front cover removed.

Otherwise, you may get an electric shock due to the high voltage terminals or exposure of charged capacitors.

Do not remove the cover except for periodic inspections or wiring, even if the input power is not applied.

Otherwise, you may access the charged circuits and get an electric shock.

Wiring and periodic inspections should be performed at least 10 minutes after disconnecting the input power and after checking the DC Link voltage is discharged with a meter (below 30VDC).

Otherwise, you may get an electric shock.

Operate the switches with dry hands.

Otherwise, you may get an electric shock.

Do not use cables with damaged insulation.

Otherwise, you may get an electric shock.

Do not subject the cables to the abrasions, excessive stress, heavy loads or pinching.

Otherwise, you may get an electric shock.



CAUTION

Install the inverter on a non-flammable surface. Do not place flammable material nearby.

Otherwise, fire could occur.

Disconnect the input power if the inverter gets damaged.

Otherwise, it could result in a secondary accident or fire.

After the input power is applied or removed, the inverter will remain hot for a couple of minutes.

Touching hot parts may result in skin burns.

Do not apply power to a damaged inverter or to an inverter with parts missing even if the installation is complete.

Otherwise, fire or accident could occur.

Do not allow lint, paper, wood chips, dust, metallic chips or other foreign matter into the drive.

Otherwise, fire or accident could occur.



WARNINGS

RECEPTION

- The SD250 is carefully tested and perfectly packed before leaving the factory.
 - In the even of transport damage, please ensure that you notify the transport agency and POWER ELECTRONICS: 902 40 20 70 (International +34 96 136 65 57) or your nearest agent, within 24hrs from receipt of the goods.
-

UNPACKING

- Make sure model and serial number of the variable speed drive are the same on the box, delivery note and unit.
 - Each variable speed drive is supplied with a SD250 technical manual.
-

RECYCLING

- Packing of the equipments should be recycled. For this, it is necessary to separate different materials included (plastic, paper, cardboard, wood, ...) and deposit them on proper banks.
 - Waste products of electric and electronic devices should be selectively collected for their correct environmental management.
-

SAFETY

- Before operating the inverter, read this manual thoroughly to gain and understanding of the unit. If any doubt exists then please contact POWER ELECTRONICS, (902 40 20 70 / +34 96 136 65 57) or your nearest agent.
 - Wear safety glasses when operating the inverter with power applied and the front cover is removed.
 - Handle the inverter with care according to its weight.
 - Install the inverter according to the instructions within this manual.
 - Do not place heavy objects on the inverter.
 - Ensure that the mounting orientation is correct.
 - Do not drop the inverter or subject it to impact.
 - The SD250 inverters contain static sensitive printed circuits boards. Use static safety procedures when handling these boards.
 - Avoid installing the inverter in conditions that differ from those described in the *Technical Characteristics* section.
-

EMC

- This type of PDS (Power Device System) is not intended to be used on a low-voltage public network which supplies domestic premises.
 - Radio frequency interference is expected if used on such a network.
-

CONNECTION PRECAUTIONS

- To ensure correct operation of the inverter it is recommended to use a SCREENED CABLE for the control wiring.
- For EMERGENCY STOP, make sure supply circuitry is open.
- Do not disconnect motor cables if input power supply remains connected. The internal circuits of the SD250 Series will be damaged if the incoming power is connected and applied to output terminals (U, V, W).
- It is not recommended to use a 3-wire cable for long distances. Due to increased leakage capacitance between conductors, over-current protective feature may operate malfunction.
- Do not use power factor correction capacitors, surge suppressors, or RFI filters on the output side of the inverter. Doing so may damage these components.
- Always check whether the DC Link LED is OFF before wiring terminals. The charge capacitors may hold high-voltage even after the input power is disconnected. Use caution to prevent the possibility of personal injury.
- Length for cables used to connect the inverter with the motor: do not exceed 50m when operating at factory default carrier frequency whenever an unshielded cable is used. If a shielded cable is used, the distance is reduced to half. For longer cable lengths, contact with Technical Department from POWER ELECTRONICS.

TRIAL RUN

- Verify all parameters before operating the inverter. Alteration of parameters may be required depending on application and load.
 - Always apply voltage and current signals to each terminal that are within levels indicated within this manual. Otherwise, damage to the inverter may result.
-

OPERATION PRECAUTIONS

- When the Auto Restart function is enabled, keep clear of driven equipment, as the motor will restart suddenly after a fault is reset.
 - The “STOP / RESET” key on the keypad is active only if the appropriate function setting has been made. For this reason, install a separate EMERGENCY STOP push button that can be operated at the equipment.
 - If a fault reset is made with the reference signal still present then a restart will occur. Verify that it is permissible for this to happen, otherwise an accident may occur.
 - Do not modify or alter anything within the inverter.
 - Before programming or operating the inverter, initialise all parameters back to factory default values.
-

EARTH CONNECTION

- The inverter is a high frequency switching device, and leakage current may flow. Ground the inverter to avoid electrical shock. Use caution to prevent the possibility of personal injury.
 - Connect only to the dedicated ground terminal of the inverter. Do not use the case or the chassis screw for grounding.
 - When installing, grounding wire should be connected first and removed last.
 - The earth cable must have a minimal cross sectional area that meets local country electrical regulations.
 - Motor ground must be connected to the drive ground terminal and not to the installation's ground. We recommend that the section of the ground connection cable should be equal or higher than the active conductor.
 - Installation ground must be connected to the inverter ground terminal.
-

1. INTRODUCTION

1.1. Configuration table

EXAMPLE

Code: SD25302

SD25	3		02	
SD250 Series	Input Voltage		Output Current	
	2	230V	01	1A
	3	400V	02	2A
		A

1.2. Standard ratings

REFERENCE	FRAME	kW	I(A)	V
SD25203	1	0.4	3	230 (3-Phase)
SD25205		0.75	5	230 (3-Phase)
SD25301		0.4	1	400 (3-Phase)
SD25302		0.75	2	400 (3-Phase)
SD25208	2	1.5	8	230 (3-Phase)
SD25304		1.5	4	400 (3-Phase)
SD25212	3	2.2	12	230 (3-Phase)
SD25217		4	17	230 (3-Phase)
SD25306		2.2	6	400 (3-Phase)
SD25309		4	9	400 (3-Phase)
SD25224	4	5.5	24	230 (3-Phase)
SD25232		7.5	32	230 (3-Phase)
SD25312		5.5	12	400 (3-Phase)
SD25316		7.5	16	400 (3-Phase)
SD25246	5	11	46	230 (3-Phase)
SD25260		15	60	230 (3-Phase)
SD25324		11	24	400 (3-Phase)
SD25330		15	30	400 (3-Phase)
SD25274	6	18.5	74	230 (3-Phase)
SD25288		22	88	230 (3-Phase)
SD25339		18.5	39	400 (3-Phase)
SD25345		22	45	400 (3-Phase)

Standard motors: 4 POLE

Software version: S/W EU 2.x

1.3. Drive description

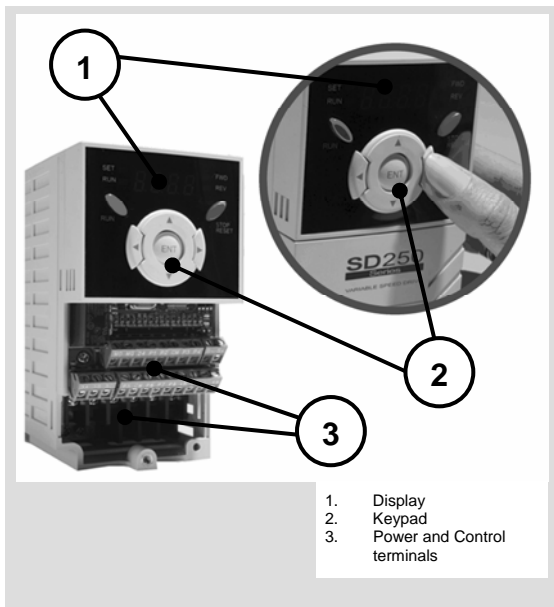

The SD250 Series offers a competitive solution within everybody reach, available in models up to 22kW, its great motor control and compact size make it ideal for any application.



2. INSTALLATION AND CONNECTION

2.1. Basic configuration

The following devices are required to operate the inverter. Proper peripheral devices must be selected and correct connections made to ensure proper operation. An inverter incorrect application or installation can result in system malfunction or reduction in product life as well as component damage. This manual should be read and understood carefully before proceeding.

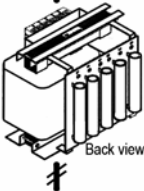
	AC Source Supply	Use the power supply within the range of inverter input power rating.
	MCCB or Ground leakage circuit breaker (ELB)	Select circuit breakers according to national and local legislation.
	Magnetic Contactor	Install it if it is necessary. When installed it do not use for the purpose of starting and stopping the inverter.
	AC Reactor	The reactors must be used when the power factor is to be improved and harmonic level has been reduced.

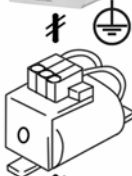
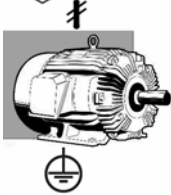
	<p>Installation and wiring</p> <p>To getting a reliable operation of the inverter, install the inverter in the proper orientation and with proper clearances. Incorrect terminal wiring can damage the equipment.</p>
	<p>DC Reactor</p> <p>DC reactor can be used to reduce harmonic level or improve power factor instead of AC reactor.</p>
	<p>Motor</p> <p>Do not connect a power factor capacitor, surge suppressor or radio noise filter to the output side of the inverter.</p>

2.2. Environmental conditions

Check the environment conditions of the installation site.

Ambient temperature should not be below -10°C (14°F) or above 50°C (122°F).

Relative humidity should be below 90% (no condensation).

Altitude should be below 1.000m (3.300ft).

The inverter should be mounted on a vertical surface. Leave a sufficient space (horizontally and vertically) respect to adjacent equipment.

- A = Higher to 100mm
- B = Higher to 50mm

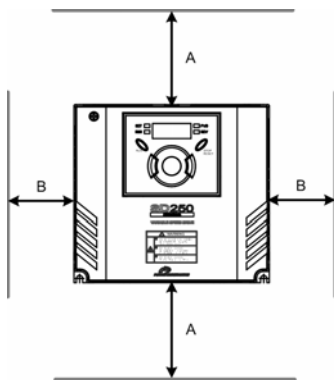

SD25ITM0001BE

Figure 2.1 SD250 mounting

When two or more inverters are installed or a cooling fan is mounted in a panel, the inverters and fan must be installed in proper positions with extreme care to keep the ambient temperature below the permissible range.

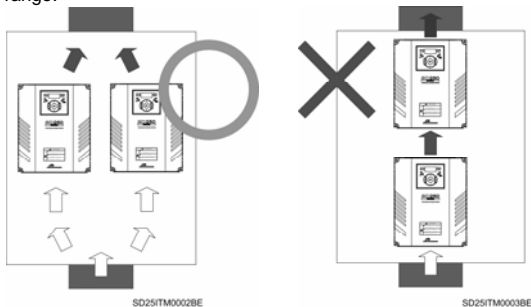

Figure 2.2 Multiple installation of inverters in a panel

Note: Take caution on proper heat ventilation when installing inverters and fans in a panel.

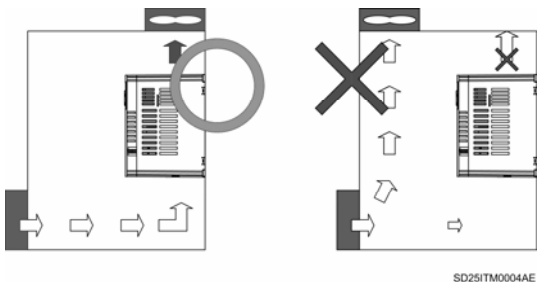

Figure 2.3 Inverter heat ventilation

2.3. Power terminals wiring

2.3.1. Equipments with power rating from 0.4 to 7.5kW

TERMINAL	DESCRIPTION
R	AC Line Voltage input (3-phase, AC 200 ~ 230V) (3-phase, AC 380 ~ 480V)
S	
T	
B1	Dynamic Brake Resistor connection terminals
B2	
U	Motor connection terminals (3-phase, AC 200 ~ 230V) (3-phase, AC 380 ~ 480V)
V	
W	
G	Ground

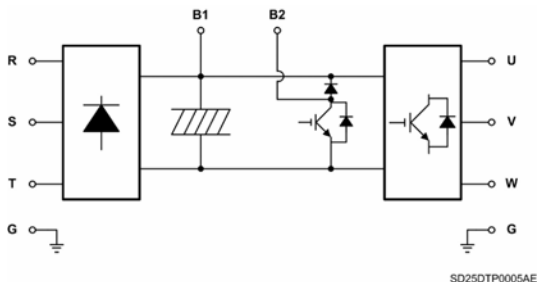

Figure 2.4 Connection of power terminals for drives from 0.4 to 7.5kW

2.3.2. Equipments with power rating from 11 to 22kW

TERMINAL	DESCRIPTION
R (L1)	AC Line Voltage input (3-phase, AC 200 ~ 230V)
S (L2)	
T (L3)	
P1(+)*	Connection terminal for DC Reactor
B1*	Connection terminal for DC Reactor / Dynamic Braking Resistor
B2	Connection terminal for Dynamic Braking Resistor
N(-)	DC voltage negative terminal
U	Motor connection terminals (3-phase, AC 200 ~ 230V)
V	
W	
G	Ground

* Terminals P1(+) and B1 are connected between them.

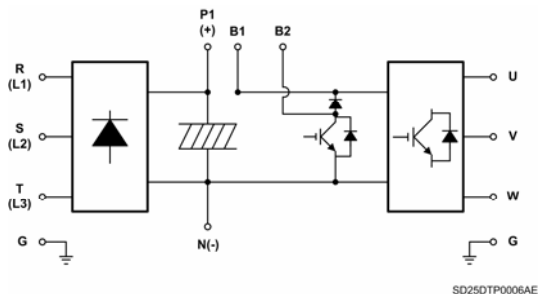

Figure 2.5 Connection of power terminals for drives from 11 to 22kW

2.3.3. Power terminals detail

Frame
1

SD25203
SD25205
SD25301
SD25302



Figure 2.6 Power terminals detail. Frames 1 and 2

Frame
2

SD25208
SD25304

Frame
3

SD25212
SD25217
SD25306
SD25309



Figure 2.7 Power terminals detail. Frame 3

Frame
4

SD25224
SD25232
SD25312
SD25316



Figure 2.8 Power terminals detail. Frame 4

Frame
5

- SD25246
- SD25260
- SD25324
- SD25330



Frame
6

- SD25274
- SD25288
- SD25339
- SD25345

Figure 2.9 Power terminals detail. Frames 5 and 6

2.3.4. Configuration of Frames 1 and 2

This configuration is valid for Frame 1 (SD25203/05, SD25301/02) and Frame 2 (SD25203/05, SD25301/02) models.

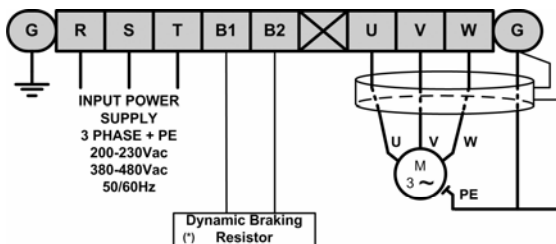

Motor cable shield should be connected to the drive and additionally to the general earth of the installation.

(*) Options

SD25DTP0001AI

Figure 2.10 Power connections for Frames 1 and 2

2.3.5. Configuration of Frame 3

This configuration is valid for Frame 3 models (SD25212/17, SD25306/09).

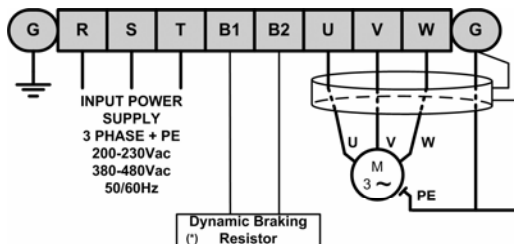

Motor cable shield should be connected to the drive and additionally to the general earth of the installation.

(*) Options

SD25DTP0002AI

Figure 2.11 Power connections for Frame 3

2.3.6. Configuration of Frame 4

This configuration is valid for Frame 4 models (SD25224/32, SD25312/16).

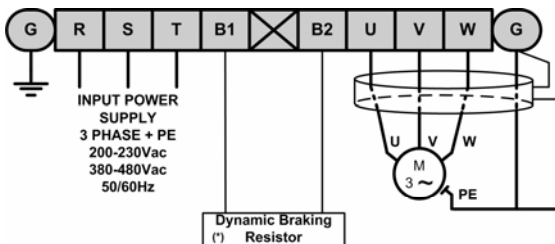

Motor cable shield should be connected to the drive and additionally to the general earth of the installation.

(*) Options

SD25DTP0003AI

Figure 2.12 Power connections for Frame 4

2.3.7. Configuration of Frames 5 and 6

This configuration is valid for Frame 5 (SD25246/60, SD25324/30) and Frame 6 (SD25274/88, SD25339/45) models.

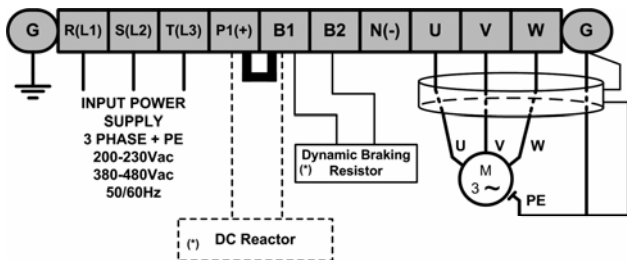

Motor cable shield should be connected to the drive and additionally to the general earth of the installation.

The connections for the DC-Reactor are the terminals P1(+) and B1; the metal bridge must be removed beforehand.

(*) Options

SD25DTP0007AI

Figure 2.13 Power connections for Frames 5 and 6

2.3.8. Wiring and cross section of terminals

Consult the following table for wiring, terminals cross section and necessary screws to connect the power input (R, S, T) and the output to the motor (U, V, W).

INVERTER Vin = 230V			Terminal screw size	Screw torque ¹ (Kgf-cm)	Cable ²			
					mm ²		AWG	
					R,S,T	U,V,W	R,S,T	U,V,W
SD25203	0.4kW	0.5CV	M3.5	10	2.5	2.5	14	14
SD25205	0.75kW	1CV	M3.5	10	2.5	2.5	14	14
SD25208	1.5kW	2CV	M3.5	10	2.5	2.5	14	14
SD25212	2.2kW	3CV	M4	15	2.5	2.5	14	14
SD25217	4kW	5.4CV	M4	15	4	4	12	12
SD25224	5.5kW	7.5CV	M5	32	6	6	10	10
SD25232	7.5kW	10CV	M5	32	10	10	8	8
SD25246	11kW	15CV	M6	30.7	14	14	6	6
SD25260	15kW	20CV	M6	30.7	22	22	4	4
SD25274	18kW	25CV	M8	30.6	30	30	2	2
SD25288	22kW	30CV	M8	30.6	30	30	2	2

¹ Apply the rated torque to terminal screws. Loosen screws can cause of short circuit and malfunction. Tightening the screw too much can damage the terminals and cause short circuit and malfunction.

² Use copper wire with 600V, 75 °C ratings for wiring.

Recommended cable section. It is absolutely necessary that the installer guaranties the correct observance of the law and the regulations that are in force in those countries or areas where this device is going to be installed.

INVERTER Vin = 400V			Terminal screw size	Screw torque ³ (Kgf-cm)	Cable ⁴			
					mm ²		AWG	
					R,S,T	U,V,W	R,S,T	U,V,W
SD25301	0.4kW	0.5CV	M3.5	10	2,5	2,5	14	14
SD25302	0.75kW	1CV	M3.5	10	2,5	2,5	14	14
SD25304	1.5kW	2CV	M4	15	2,5	2,5	14	14
SD25306	2.2kW	3CV	M4	15	2,5	2,5	14	14
SD25309	4kW	5.4CV	M4	15	2,5	2,5	14	14
SD25312	5.5kW	7.5CV	M5	32	4	4	12	12
SD25316	7.5kW	10CV	M5	32	4	4	12	12
SD25324	11kW	15CV	M5	30.7	6	6	10	10
SD25330	15kW	20CV	M5	30.7	14	6	14	6
SD25339	18kW	25CV	M6	30.6	14	6	14	6
SD25345	22kW	30CV	M6	30.6	22	4	22	4

³ Apply the rated torque to terminal screws. Loosen screws can cause of short circuit and malfunction. Tightening the screw too much can damage the terminals and cause short circuit and malfunction.

⁴ Use copper wire with 600V, 75 °C ratings for wiring.

Recommended cable section. It is absolutely necessary that the installer guaranties the correct observance of the law and the regulations that are in force in those countries or areas where this device is going to be installed.

2.4. Power supply and motor connection

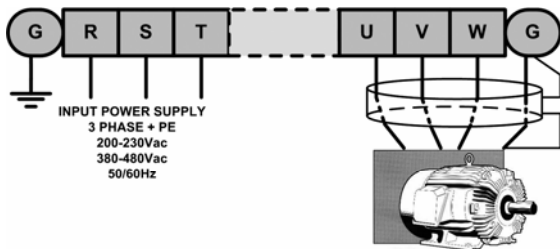

SD25DTP0004BI

Figure 2.14 Power supply and motor connection

Power supply must be connected to the R, S, and T Terminals.

Connecting it to the U, V and W terminals causes internal damages to the inverter. Arranging the phase sequence is not necessary.

Motor should be connected to the U, V and W Terminals. If the forward control digital input (FX - P1 multi-function input) is on, the motor should rotate counter clockwise when viewed from the load side of the motor. If the motor rotates in the reverse, switch the U and V terminals.

2.5. Control terminals wiring

2.5.1. Control terminals detail

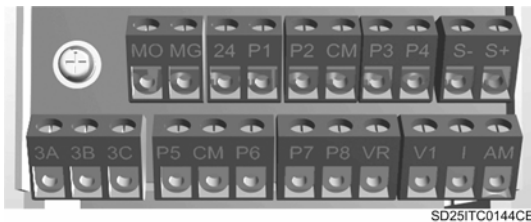

Figure 2.15 Detail 1 of control terminals

Connection precautions

Use screened or braided wires to connect the circuit control, separating these cables of the main power supply and other high voltage circuits.

We recommend the use of screened cables with a minimum section of 0.5mm² for control terminals connection.

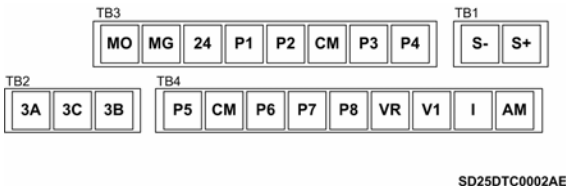

Figure 2.16 Detail 2 of control terminals

Control terminals description

TYPE	SYMBOL	NAME	DESCRIPTION	
Input Signals	Digital Inputs	P1	Forward Run Command	When the contact is activated on this terminal, the inverter runs in forward direction and stops when the contact is deactivated (FX is the factory default). Also it can be configured as P1 – P8.
		P2	Reverse Run Command	When the contact is activated on this terminal, the inverter runs in reverse direction and stops when the contact is deactivated (RX is the factory default). Also it can be configured as P1 – P8.
		P3	Emergency Stop	When the contact is activated over this terminal (BX signal is ON) the inverter output is disconnected. When motor uses an electric brake to stop, BX function is used to disconnect the output signal. When BX signal is OFF and FX signal (or RX) is ON, The motor continues operating. Be careful. Also it can be configured as P1 – P8.
		P4	Fault Reset	When the contact is activated on this terminal, the inverter is reset after a failure occurs (RST is the factory default). Also it can be configured as P1 – P8.
		P5	Jog Operation	When the contact is activated on this terminal, the inverter runs in fixed speed programmed as JOG frequency and stops when the contact is deactivated (JOG Freq. Is the factory default). Also it can be configured as P1 – P8.
		P6, P7, P8	Configurable Digital Inputs 6, 7 and 8	Configurable input terminals where digital inputs are defined (Multi-step freq.-Low, Multi-step freq.-Middle and Multi-step freq.-High are the factory defaults) Also it can be configured as P1 – P8.
		CM	(NPN) Common / 24V Common	Common terminal for NPN input contacts and Common terminal for DC 24V external supply too.

Control terminals description

TYPE		SYMBOL	NAME	DESCRIPTION
Input Signals	Analogue Inputs	VR	Supply for Analog. signal (+12V)	Supply for the reference analogue signal (Potentiometer: 1 – 5k Ω). Maximum output: DC +10V, 100mA.
		V1	Reference Frequency signal (Voltage)	Terminal used for giving the inverter the speed reference, using a voltage supply between DC 0-10V.
		I	Reference Frequency signal (Current)	Terminal used for giving the inverter the speed reference, using a current supply between 0-20mA. (Internal resistor: 500 Ω).
Output Signals	Digital Outputs	3A, 3C, 3B	Multi-function Relay	Active commutate contact (250Vac, 1A; 30Vdc, 1A). With fault: 3A-3C Close (3B-3C Open). Without fault: 3B-3C Close (3A-3C Open).
		MO	Multi-function Output for open collector	Below DC 26V, 100mA.
		MG	Ground terminal for external power supply	
	Analog. Outputs	AM	Multi-function Output Terminal	Multi-function output signal DC 0 – 10V, max. 100mA.
		24	(PNP) Common / DC 24V External power supply	DC 24V common terminal for PNP input contacts. It can be used for external power supply (maximum: +24V, 100mA).
RS485	Communications	S+, S-	RS485 High and Low signals	RS485 communication signals.

SD250 Series provides two operation modes to connect input signals: NPN or PNP. The corresponding methods of connection are showed below:

NPN mode: When S8 is set to NPN (high position). In this case, input terminals will be activated using internal power supply of the inverter. CM terminal (DC 24V GND) will be the common terminal for input signal contacts.

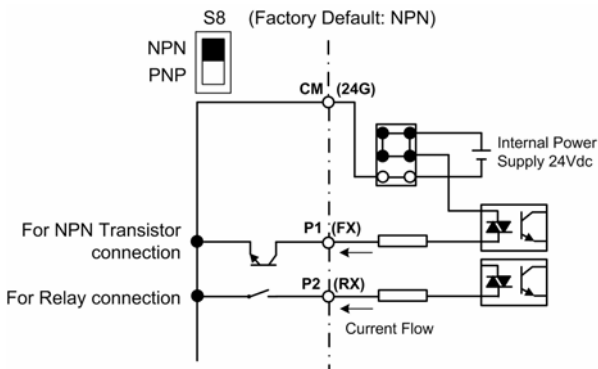

SD25DTC0003AI

Figure 2.17 Control terminals in NPN configuration

PNP mode (external power supply): When S8 is set to PNP (low position). In this case, input terminals will be activated using DC 24V external power supply, but with the reference terminal joined to the inverter CM terminal. 24 terminal (DC 24V) of the above-mentioned power supply will be the common terminal for input signal contacts.

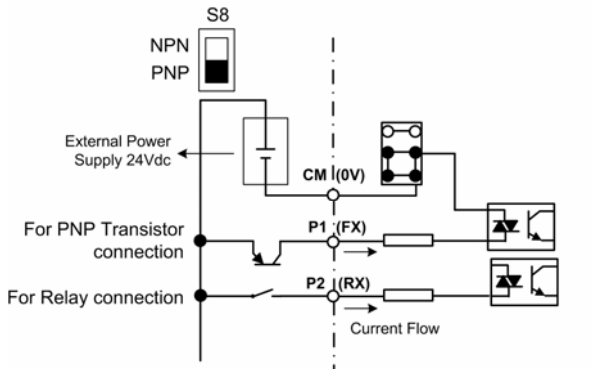

SD25DTC0004AI

Figure 2.18 Control terminals in PNP configuration and external power supply

2.5.2. Basic connection of control terminals

Connection of digital input and output is common for all inverter powers, just as the following figure shows:

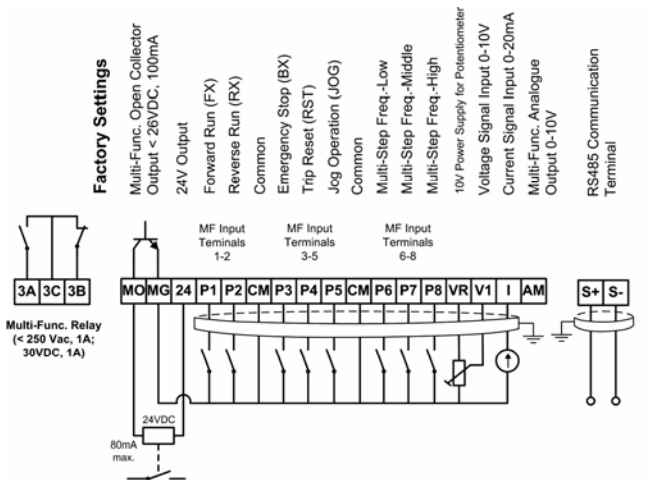

Note: The MO output has been designed for a maximum current of 80mA.

SD25DTC0001C1

Figure 2.19 Basic connection of control terminals for SD250 Series

3. TECHNICAL CHARACTERISTICS

INPUT	Power supply	200 to 230Vac (-15%, +10%) (3-phase) 380 to 480Vac (-15%, +10%) (3-phase)
	Input frequency	50 ÷ 60Hz ± 5%
	Input power factor	> 0.98 (of fundamental)
	Momentary power loss	> 15ms
OUTPUT	Motor output voltage	0Vac to V. Input
	Overload capacity	150% for 60 sec.
	Frequency ratings	0.01Hz to ± 400Hz
	Efficiency (at full load)	>98%
	Control method	Space vector technology
	Carrier frequency	Maximum 15kHz
ENVIRONMENTAL CONDITIONS	Degree of protection	IP20
	Ambient temperature	-10°C to 50°C
	Storage temperature	-20°C to +65°C
	Ambient humidity	<90%, non-condensing
	Altitude	1000m
	Altitude de-rating (>1000)	-1% per 100m; maximum 3000m
	Vibration	5.9m/sec ² (=0.6g).
Installation site	Recommended: environment with no corrosive gas, combustible gas, oil mist or dust	
CONTROL	Control method	V / Hz control, Vector control (Sensorless)
	Analogue inputs	1 input 0-10Vdc, ±10Vdc, 1 input 0-20mA or 4-20mA input
	Digital inputs	8 programmable inputs
	Analogue outputs	1 output 0-10Vdc
	Relay outputs	1 change over relay (250Vac, 1A; 30Vdc, 1A) 1 open collector transistor programmable (26Vdc, 100mA)
	Display unit	Control Panel and Digital programming with independent memory (optional)
	Communications port	RS485 ModBus RTU protocol (DeviceNet and Profibus optional)
	Dynamic braking unit	Built in
Normative	CE, UL, cUL, cTick	

MOTOR PROTECTIONS	Motor thermal model Ground fault Overload warning Motor stall warning Dynamic brake resistor thermal model Torque limit and torque limit time (adjustable) Low voltage 20% dynamic brake duty cycle Input/Output phase loss Phases current imbalance Stall motor protection Short circuit Over voltage Mean torque 100% of braking during 5 sec Communications fault
SD250 SETTINGS	Thermal model (software) IGBTs overload Over-voltage fault Hardware fault Heatsink over-temperature Output current limit Regeneration limit Cooling fan fault Pressure group function Double acceleration ramp Second motor setting

4. DIMENSIONS

4.1. Dimensions of Frame 1

INVERTER REF.	INVERTER DIMENSIONS (mm)								NET WEIGHT (kg) Inverter
	H1	H2	W1	W2	D	Ø	A	B	
SD25203	128	119	70	65,5	130	4,0	4,5	4,0	0,76
SD25205	128	119	70	65,5	130	4,0	4,5	4,0	0,77
SD25301	128	119	70	65,5	130	4,0	4,5	4,0	0,76
SD25302	128	119	70	65,5	130	4,0	4,5	4,0	0,77

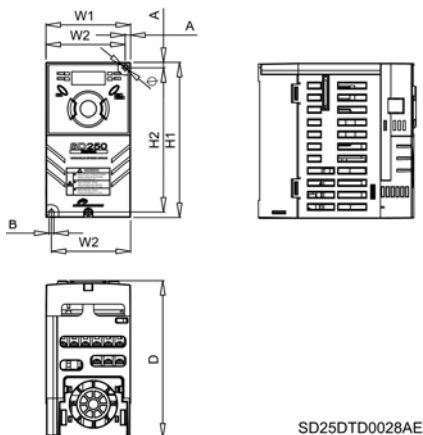

Figure 4.1 Dimensions of Frame 1

4.2. Dimensions of Frame 2

INVERTER REF.	INVERTER DIMENSIONS (mm)								NET WEIGHT (kg)
	H1	H2	W1	W2	D	Ø	A	B	Inverter
SD25208	128	120	100	95,5	130	4,5	4,5	4,5	1,12
SD25304	128	120	100	95,5	130	4,5	4,5	4,5	1,12

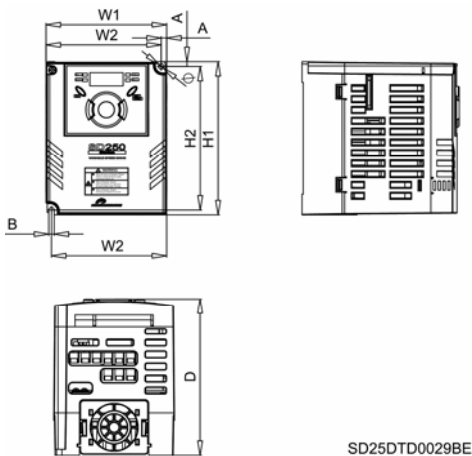
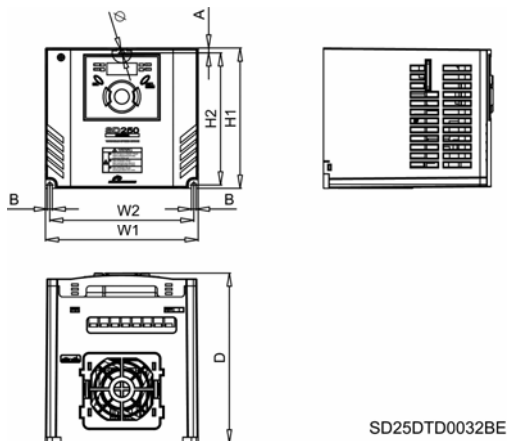

Figure 4.2 Dimensions of Frame 2

4.3. Dimensions of Frame 3

INVERTER REF.	INVERTER DIMENSIONS (mm)								NET WEIGHT (kg) Inverter
	H1	H2	W1	W2	D	Ø	A	B	
SD25212	128	120,5	140	132	155	4,5	4,5	4,5	1,84
SD25217	128	120,5	140	132	155	4,5	4,5	4,5	1,89
SD25306	128	120,5	140	132	155	4,5	4,5	4,5	1,84
SD25309	128	120,5	140	132	155	4,5	4,5	4,5	1,89



SD25DTD0032BE

Figure 4.3 Dimensions of Frame 3

4.4. Dimensions of Frame 4

INVERTER REF.	INVERTER DIMENSIONS (mm)								NET WEIGHT (kg) Inverter
	H1	H2	W1	W2	D	Ø	A	B	
SD25224	220	210	180	170	170	4,5	5,0	4,5	3,66
SD25232	220	210	180	170	170	4,5	5,0	4,5	3,66
SD25312	220	210	180	170	170	4,5	5,0	4,5	3,66
SD25316	220	210	180	170	170	4,5	5,0	4,5	3,66

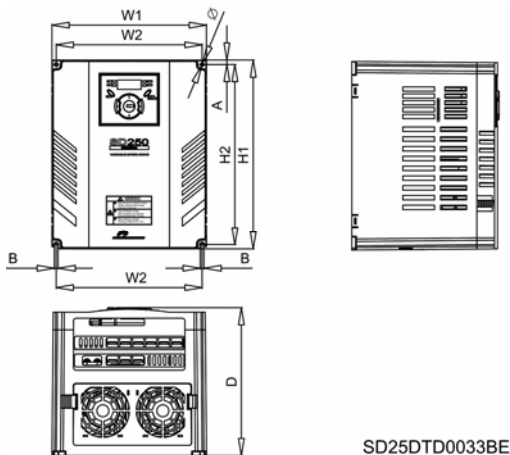

Figure 4.4 Dimensions of Frame 4

4.5. Dimensions of Frame 5

INVERTER REF.	INVERTER DIMENSIONS (mm)								NET WEIGHT (kg) Inverter
	H1	H2	W1	W2	D	Ø	A	B	
SD25246	320	304	235	219	189,5	7,0	8,0	7,0	9,0
SD25260	320	304	235	219	189,5	7,0	8,0	7,0	9,0
SD25324	320	304	235	219	189,5	7,0	8,0	7,0	9,0
SD25330	320	304	235	219	189,5	7,0	8,0	7,0	9,0

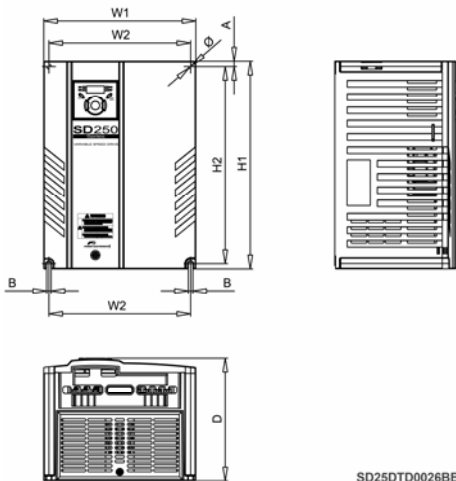

Figure 4.5 Dimensions of Frame 5

4.6. Dimensions of Frame 6

INVERTER REF.	INVERTER DIMENSIONS (mm)								NET WEIGHT (kg)
	H1	H2	W1	W2	D	Ø	A	B	Inverter
SD25274	410	392	260	240	208,5	10,0	10,0	10,0	13,3
SD25288	410	392	260	240	208,5	10,0	10,0	10,0	13,3
SD25339	410	392	260	240	208,5	10,0	10,0	10,0	13,3
SD25345	410	392	260	240	208,5	10,0	10,0	10,0	13,3

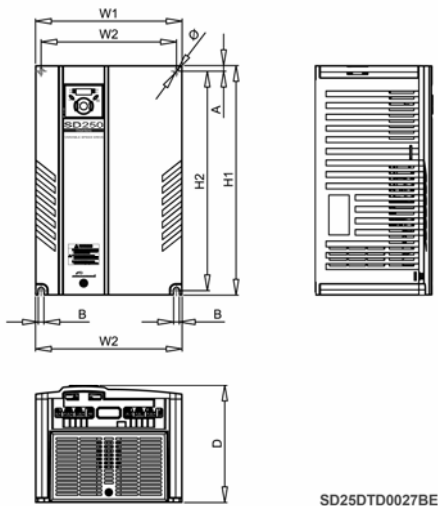

Figure 4.6 Dimensions of Frame 6

5. POWER RANGE

REFERENCE	FRAME	STANDARD TYPES			
		V (-15%, +10%)	I (A)	kW	CV
SD25203	1	200-230 III	3	0.4	0.5
SD25205		200-230 III	5	0.75	1
SD25301		380-480 III	1.25	0.4	0.5
SD25302		380-480 III	2.5	0.75	1
SD25208	2	200-230 III	8	1.5	2
SD25304		380-480 III	4	1.5	2
SD25212	3	200-230 III	12	2.2	3
SD25217		200-230 III	17	4	5.4
SD25306		380-480 III	6	2.2	3
SD25309		380-480 III	9	4	5.4
SD25224	4	200-230 III	24	5.5	7.5
SD25232		200-230 III	32	7.5	10
SD25312		380-480 III	12	5.5	7.5
SD25316		380-480 III	16	7.5	10
SD25246	5	200-230 III	46	11	15
SD25260		200-230 III	60	15	20
SD25324		380-480 III	24	11	15
SD25330		380-480 III	30	15	20
SD25274	6	200-230 III	74	18.5	25
SD25288		200-230 III	88	22	30
SD25339		380-480 III	39	18.5	25
SD25345		380-480 III	45	22	30

6. CONFORMITY DECLARATION

Directives from which the conformity is declared are:

2006/95/CE and 2004/108/CE

Producto Product	VARIADOR (Variador de Velocidad) Variable Speed Drive
Marca comercial Trade Mark	POWER ELECTRONICS
Modelo /Tipo Ref. Model / Type Ref.	SD250 SERIES
Fabricante Manufacturer	LS Industrial Systems Co., Ltd. 181, Samsung-Ri, Mokchon-Eup, Chonan, Chungnam 330-845 Corea
Peticionario Tested on request of	POWER ELECTRONICS ESPAÑA, S.L. C/. Leonardo da Vinci, 24-26 Parque Tecnológico 46980 · PATERNA · VALENCIA ESPAÑA

Technical standard

The standards applied in order to comply with the essential requirements of the Directives 2006/95/CE "Electrical material intended to be used with certain limits of voltage" and 2004/108/CE "Electromagnetic Compatibility" are the following ones:

NORM	DESCRIPTION
EN 50178:1997	Electronic equipment for use in power installations.
EN 61800-3:2003	Adjustable speed electrical power drive systems. Part 3: EMC product standard including specific test methods.
EN 55011:2007/A2:2007	Industrial, scientific and medical (ISM) radio-frequency equipment - Electromagnetic disturbance characteristics - Limits and methods of measurement.
EN 61000-4-2:1995/A2:2001	Electromagnetic compatibility (EMC). Part 4-2: Testing and measurement techniques - Electrostatic discharge immunity test.
EN 61000-4-3:2002/A1:2002	Electromagnetic compatibility (EMC). Part 4-3: Testing and measurement techniques - Radiated, radio-frequency, electromagnetic field immunity test.
IEC 61000-4-4:2004	Electromagnetic compatibility (EMC). Part 4-4: Testing and measurement techniques - Electrical fast transient/burst immunity test.
EN 61000-4-5:2006	Electromagnetic compatibility (EMC). Part 4-5: Testing and measurement techniques - Surge immunity test (IEC 61000-4-5:2005).
EN 61000-4-6:1996/A1:2001	Electromagnetic compatibility (EMC). Part 4-6: Testing and measurement techniques - Immunity to conducted disturbances, induced by radio-frequency fields.

NORM	DESCRIPTION
CEI/TR 61000-2-1:1990	Electromagnetic compatibility (EMC). Part 2: Environment. Environment description for low-frequency conducted disturbances and signalling in public low voltages supply systems.
EN 61000-2-2:2002	Electromagnetic compatibility (EMC). Part 2-2: Environment - Compatibility levels for low-frequency conducted disturbances and signalling in public low-voltage power supply systems.

7. PROGRAMMING KEYPAD

7.1. Parameters groups

SD250 Series inverter has available four independent parameters groups according to its function indicated at the following table:

Parameters group	Display	Description
Main menu	DRV	Basic parameters that are necessary to inverter performance. Parameters such as Frequency command (reference frequency), acceleration/deceleration time.
Function 1 menu	FU1 (F)	Operation basic parameters to set output frequency and voltage. Run/Stop, frequency limits, torque boost, thermal protections.
Function 2 menu	FU2 (H)	Operation advanced parameters to set PID operation and a second motor. Fault history, motor nameplate, second acceleration/deceleration, save parameters keypad/inverter, parameter lock.
I/O	I/O (I)	Parameters that are necessary to configure a sequence using multi-function input/output terminals. Input and output settings, multiple frequency and acceleration select.

Note: See figure on next page.

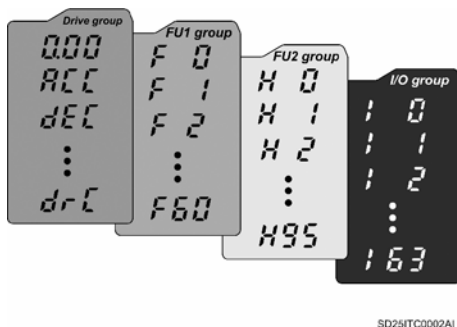

Figure 7.1 Parameters group of SD250 inverters

7.2. Keypad / display characteristics

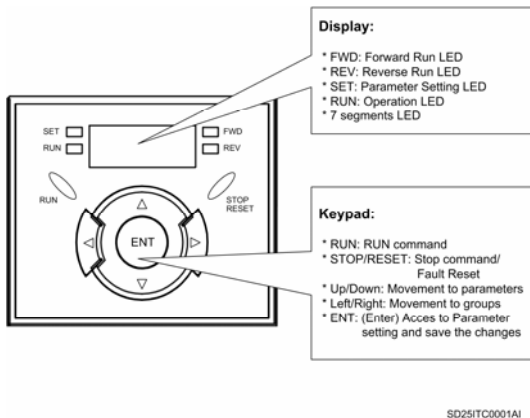

Figure 7.2 Keypad / Display of SD250 inverters

DISPLAY		
FWD		Lit during Forward Run.
REV		Lit during Reverse Run.
RUN		Lit during operation.
SET		Lit during parameters setting.
7 Segments		Display operation status and parameter information.
KEYPAD		
RUN		It allows giving the Run command (RUN).
STOP/RESET		STOP: It allows giving the Stop command during operation. RESET: It allows giving the Reset command after a fault is occurred.
▲	UP	Used to scroll up through parameters or increase parameter value when it is being programmed.
▼	DOWN	Used to scroll down through parameters or decrease parameter value when it is being programmed.
◀	LEFT	Used to jump to other parameter groups counter clockwise or move cursor to the left to change the parameter value.
▶	RIGHT	Used to jump to other parameter groups clockwise or move cursor to the right to change the parameter value.
●	ENTER	Used to set the parameter value or save the changed parameter value.

7.3. Alphanumerical displaying

0	0	A	A	K	K	U	U
1	1	b	B	L	L	v	V
2	2	c	C	m	M	"	W
3	3	d	D	n	N	4	X
4	4	E	E	O	O	y	Y
5	5	F	F	P	P	z	Z
6	6	G	G	Q	Q		
7	7	H	H	r	R		
8	8	I	I	S	S		
9	9	J	J	t	T		



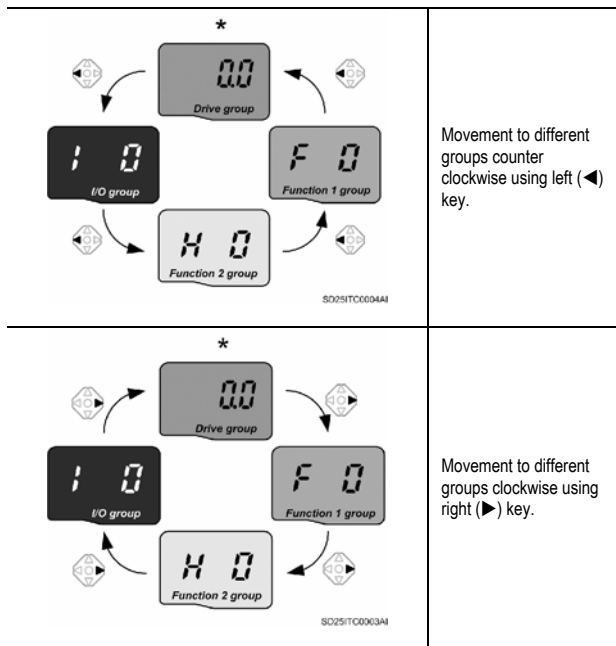

7.4. Movement to different groups

It is only available from the first parameter of each group as the showed figure below:



* Reference frequency can be set at **0.0** (the first parameter of drive group), even though the preset value is 0.0, it is user-settable. The changed frequency will be displayed after is changed.

7.4.1. Movement to other groups from the first parameter of each group

1		<ul style="list-style-type: none"> - The first parameter in Drive group (DRV) "0.00" will be displayed when AC input power is applied. - Press the right arrow (▶) key once to go to Function 1 group (F).
2		<ul style="list-style-type: none"> - The first parameter in Function 1 group (F), 'F0' will be displayed. - Press the right arrow (▶) key once to go to Function 2 group (H).
3		<ul style="list-style-type: none"> - The first parameter in Function 2 group (H), 'H0' will be displayed. - Press the right arrow (▶) key once to go to I/O group (I).
4		<ul style="list-style-type: none"> - The first parameter in I/O group (I), 'I0' will be displayed. - Press the right arrow (▶) key once again to return to Drive group (DRV).
5		<ul style="list-style-type: none"> - Return to the first parameter in Drive group (DRV) "0.00".

Note: If the left arrow (◀) key is used, the above will be executed in the reverse order.

7.4.2. Movement to other groups from any parameter (not the first parameter) of a group

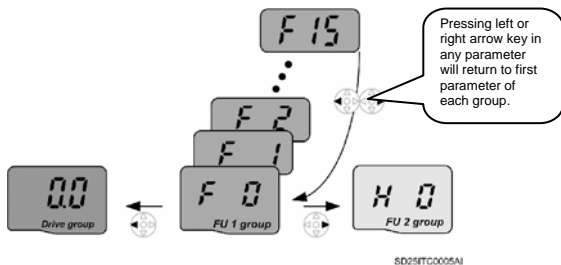





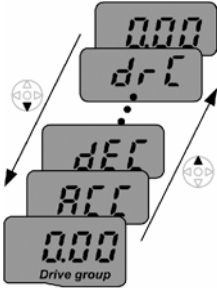

To move from F15 to Function 2 group:

1		- From F15, press the left (◀) or right arrow (▶) key. Pressing the key goes to the first parameter of the group.
2		- The first code in Function 1 group, F0, is displayed. - Press the right arrow (▶) key.
3		- The first parameter in Function 2 group, H0, will be displayed.

7.5. Movement to different parameters of a group

7.5.1. Movement through parameters of Drive group

 <p>SD25ITC0006A1</p>	1		<ul style="list-style-type: none"> - From the first parameter of Drive group "0.00", press the up (▲) key once.
	2		<ul style="list-style-type: none"> - The second parameter in Drive group 'ACC' is displayed. - Press the up (▲) key once.
	3		<ul style="list-style-type: none"> - The third parameter in Drive group 'dEC' is displayed. - Keep pressing the up (▲) key until the last parameter appears.
	4		<ul style="list-style-type: none"> - The last parameter in Drive group 'drC' is displayed. - Press the up (▲) key again.
	5		<ul style="list-style-type: none"> - Return to the first parameter of Drive group.
<p>Note: Use the down (▼) key for the opposite order.</p>			

7.5.2. Parameter jump

Direct movement from F0 to F15.

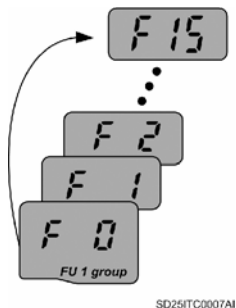



1		- Press the Ent key in F0.
2		- "1" (F1 parameter number) is displayed. Use the up (▲) key to set to "5".
3		- "05" is displayed by pressing the left (◀) key once to move the cursor to the left. The numeral which has the cursor is displayed brighter. In this case, "0" is active. - Use the up (▲) key to set to "1".
4		- "15" is set. - Press the Ent key once.
5		- Movement to F15 has been completed.

Note: Function 2 group and I/O group are settable in the same way.

7.5.3. Movement through parameters of a group step by step

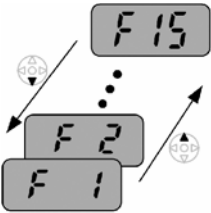
Movement from F1 to F15 in FU 1 group.

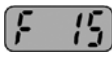
 <p style="text-align: center;">SD25ITC0008AE</p>	1		- From F1, continue pressing the up (▲) key until F15 is displayed.
	2		- Movement to F15 has been completed.
Note: Applicable to Function 2 and I/O groups.			

Note: Some parameters are not displayed while moving through parameters using the up (▲)/down (▼) keys. That is because it is programmed that some parameters are intentionally left blank for future use or are invisible because they are not used by user.

For example, when 'F24 → Frequency limits selection' is set to '0 → No', 'F25 → High frequency limit' and 'F26 → Low frequency limit' are not displayed during movement through parameters. But when 'F24' is set to '1 → Yes', 'F25' and 'F26' will appear on the display.

7.6. Parameters setting

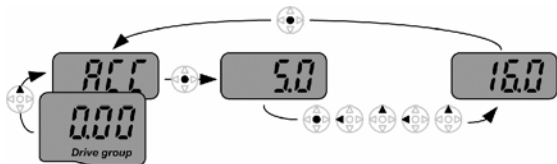

7.6.1. Change parameter values in Drive group

Change of ACC time from 5.0 sec to 16.0 sec.



SD25(ITC0009A)

1		- From the first parameter "0.00", press the up (▲) key once to go to the second parameter.
2		- 'ACC' (Accel time) is displayed. - Press the Ent key once.
3		- Preset value is "5.0", and the cursor is in the digit "0". - Press the left (◀) once to move the cursor to the left.
4		- The digit "5" is active. Then press the up (▲) key once.
5		- The value is increased to "6.0". - Press the left (◀) key to move the cursor to the left.

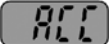
6		<ul style="list-style-type: none">- "0.60" is displayed. The first "0" is active.- Press the up (▲) key once.
7		<ul style="list-style-type: none">- "16.0" is set.- Press the Ent key once.- "16.0" is blinking.- Press the Ent key again to return to the parameter name.
8		<ul style="list-style-type: none">- 'ACC' is displayed. Acceleration time has been changed from "5.0" to "16.0" sec.

Note: Pressing the left (◀)/ right (▶)/ up (▲)/ down (▼) keys while the cursor is blinking, the parameter value change will be cancelled. Pressing the **Ent** key in this status will enter the value into memory.

7.6.2. Frequency setting

Setting of run frequency to 30.05Hz in Drive group.



SD250TC0010A1

1		- In "0.00", press the Ent key once.
2		- The second decimal "0" becomes active. - Press the up (▲) key until "5" is displayed.
3		- Press the left (◀) key once.
4		- The first decimal "0" becomes active. - Press the left (◀) key once.
5		- Press the left (◀) key once.
6		- Set "3" using the up (▲) key.
7		- Press the Ent key. - "30.05" is blinking. - Press the Ent key.
8		- "30.05" is entered into memory.

Note: SD250 display can be extended to 5 digits using left (◀)/ right (▶) keys.



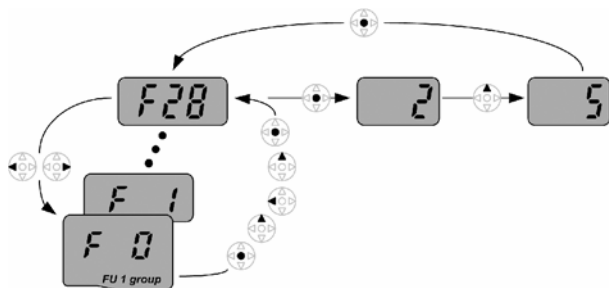

7.6.3. Change of a parameter value in Function 1 group

Change of F28 parameter value from "2" to "5".



SD25ITC0011AI

1		- In F0, press the Ent key once.
2		- "1" (parameter number of F1) is displayed. - Increase the value to "8" pressing the up (▲) key.
3		- When "8" is set, press the left (◀) key once.
4		- "0" is active. - Increase the value to "2" pressing the up (▲) key.
5		- "20" is displayed. - Press the Ent key once.

6		<ul style="list-style-type: none">- The parameter number 28 (F28) is displayed.- Press the Ent key once to check the set value.
7		<ul style="list-style-type: none">- The preset value "2" is displayed.- Increase the value to "5" using the up (▲) key.
8		<ul style="list-style-type: none">- Press the Ent key.
9		<ul style="list-style-type: none">- Parameter number will appear next. Parameter value change is complete.- Press the left (◀) or right (▶) key until arrive to the first parameter of the group.
10		<ul style="list-style-type: none">- Movement to the first parameter of Function 1 group is complete.

Note: Applicable to parameters value setting in Function 2 and I/O groups too.

7.7. Operation status monitoring

7.7.1. Output current display

Monitoring of output current in Drive group.

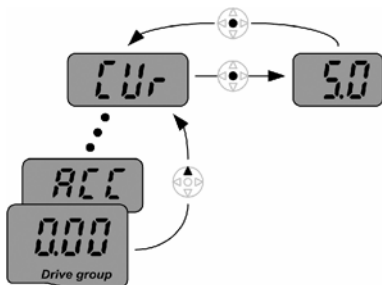

SD25ITC0012AI

1		- In "0.0", continue pressing the up (▲) or down (▼) key until 'CUR' is displayed.
2		- Monitoring of output current is provided in this parameter. - Press the Ent key once to check the current.
3		- Present output current is 5A. - Press the Ent key once to return to the parameter name.
4		- Return to the output current monitoring parameter.

Note: Other parameters in Drive group such as 'dCL → Inverter DC Link current or 'vOL → Inverter output voltage' can be monitored in the same way.

7.7.2. Fault display

How to monitor fault condition in Drive group.

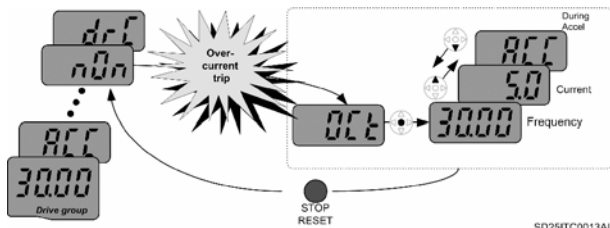

SD25ITC0013AJ

1		<ul style="list-style-type: none"> - This message appears when an Over current fault occurs. - Press the Ent or up (▲) or down (▼) key once.
2		<ul style="list-style-type: none"> - The run frequency at the time of fault (30.0) is displayed. - Press the up (▲) key once.
3		<ul style="list-style-type: none"> - The output current at the time of fault is displayed. - Press the up (▲) key once.
4		<ul style="list-style-type: none"> - Operation status is displayed. A fault occurred during acceleration. - Press the STOP/RESET key once.
5		<ul style="list-style-type: none"> - The fault condition is cleared and "nOn" is displayed.

When more than one fault occur at the same time.

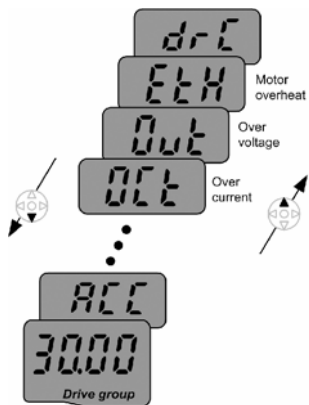

SD25/TC0014AI

- Maximum three faults information is displayed as shown left.

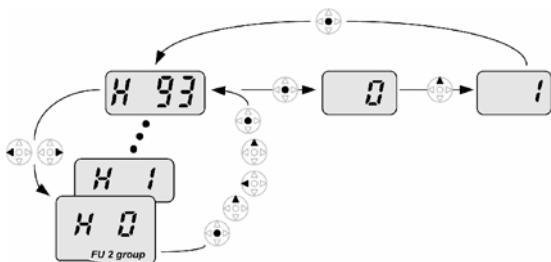

7.7.3. Parameters initialize

How to initialize parameters of all four groups in H93.

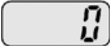

SD25ITC0015A1

1		- In H0, press the Ent key once.
2		- Parameter number of H1, "1", is displayed. - Increase the value to "3" pressing the up (▲) key several times.
3		- In "3", press the left (◀) key once to move the cursor to the left.
4		- "03" is displayed and 0 is active. - Increase the value to "9" pressing the up (▲) key several times.
5		- "93" is displayed. - Press the Ent key once.

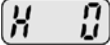
6		<ul style="list-style-type: none">- The parameter number H93 is displayed.- Press the Ent key once.
7		<ul style="list-style-type: none">- Present value is "0".- Press the up (▲) key once to set to "1" to activate parameter initialize.
8		<ul style="list-style-type: none">- Press the Ent key once.
9		<ul style="list-style-type: none">- Return to the parameter number after blinking. Parameter initialize has been completed.- Press the left (◀) or right (▶) key.
10		<ul style="list-style-type: none">- Return to H0.

8. PARAMETERS LIST

8.1. Drive group (DRV)

Parameter	Description	Range	Default value	Memory address	Function	Set during RUN												
0.00	Reference frequency	0.00 – 400Hz	0.00Hz	A100	This parameter sets the frequency that the inverter is commanded to output. During Stop: Reference frequency. During Run: Output frequency. During Multi-step operation: Multi-step frequency 0. It cannot be set higher than 'F21 → Maximum frequency'.	YES												
ACC	Acceleration time	0.0 – 6000 sec	5.0 sec	A101	This parameter sets the accel/decel time. During multi-accel/decel operation (multiple accelerations / decelerations) this parameter serves as accel/decel time 0.	YES												
dEC	Deceleration time		10.0 sec	A102		YES												
drv	Drive mode	0 – 3	1	A103	<table border="1"> <tr> <td>0</td> <td>Run/Stop by Run/Stop key on the keypad</td> <td></td> </tr> <tr> <td>1</td> <td></td> <td>FX: Motor forward run RX: Motor reverse run</td> </tr> <tr> <td>2</td> <td>Terminal operation</td> <td>FX: Run/Stop enable RX: Reverse rotation selection</td> </tr> <tr> <td>3</td> <td>RS485 Communication</td> <td></td> </tr> </table>	0	Run/Stop by Run/Stop key on the keypad		1		FX: Motor forward run RX: Motor reverse run	2	Terminal operation	FX: Run/Stop enable RX: Reverse rotation selection	3	RS485 Communication		NO
0	Run/Stop by Run/Stop key on the keypad																	
1		FX: Motor forward run RX: Motor reverse run																
2	Terminal operation	FX: Run/Stop enable RX: Reverse rotation selection																
3	RS485 Communication																	

Parameter	Description	Range	Default value	Memory address	Function	Set during RUN		
Frq	Frequency setting mode	0 – 8	0	A104	0	Digital	Keypad setting 1	NO
					1		Keypad setting 2	
					2	Analogue	V1 Mode 1: -10 – +10V	
					3		V1 Mode 2: 0 – +10V	
					4		Terminal I: 0 – 20mA	
					5		Terminal V1 Mode 1 setting + Terminal I	
					6		Terminal V1 Mode 2 setting + Terminal I	
					7		RS485 Communication	
					8	Motorized Potentiometer (Up/Down mode)		
St1	Multi-step frequency 1	0.00 – 400Hz	10.00Hz	A105	It sets multi-step frequency 1 during multi-step operation (multiple speeds). Note: In PID mode, PID multi-reference 1 setting. It is set in Hz (Max. Freq. (Hz) = 100% PID Ref.).	YES		
St2	Multi-step frequency 2		20.00Hz	A106	It sets multi-step frequency 2 during multi-step operation (multiple speeds). Note: In PID mode, PID multi-reference 2 setting. It is set in Hz (Max. Freq. (Hz) = 100% PID Ref.).	YES		
St3	Multi-step frequency 3		30.00Hz	A107	It sets multi-step frequency 3 during multi-step operation (multiple speeds). Note: In PID mode, PID multi-reference 3 setting. It is set in Hz (Max. Freq. (Hz) = 100% PID Ref.).	YES		
CUr	Output current	-	-	A108	It displays the output current to the motor.	-		
rPM	Motor RPM	-	-	A109	It displays the number of motor RPM.	-		
dCL	Inverter DC Link voltage	-	-	A10A	It displays DC Link voltage inside the inverter.	-		

Parameter	Description	Range	Default value	Memory address	Function	Set during RUN											
vOL	User display selection	vOL Por tOr	vOL	A10B	<table border="1"> <tr> <td colspan="2">This parameter displays the item selected at 'H73 → Selection of user screen'.</td> </tr> <tr> <td>vOL</td> <td>Output voltage</td> </tr> <tr> <td>Por</td> <td>Output power</td> </tr> <tr> <td>tOr</td> <td>Torque</td> </tr> </table>	This parameter displays the item selected at 'H73 → Selection of user screen'.		vOL	Output voltage	Por	Output power	tOr	Torque	-			
This parameter displays the item selected at 'H73 → Selection of user screen'.																	
vOL	Output voltage																
Por	Output power																
tOr	Torque																
nOn	Fault display	-	-	A10C	It displays the types of faults, frequency and operating status at the time of the fault.	-											
drC	Selection of motor rotation direction	F, r	F	A10D	<table border="1"> <tr> <td colspan="2">Sets the direction of motor rotation when 'drv → Drive mode' is set to 0.</td> </tr> <tr> <td>F</td> <td>Forward</td> </tr> <tr> <td>r</td> <td>Reverse</td> </tr> </table>	Sets the direction of motor rotation when 'drv → Drive mode' is set to 0.		F	Forward	r	Reverse	YES					
Sets the direction of motor rotation when 'drv → Drive mode' is set to 0.																	
F	Forward																
r	Reverse																
drv2 ¹	Drive mode 2	0 – 3	1	A10E	<p>If one of the digital inputs ('I17' to 'I24') configured with option '22' is activated, the values set in parameters 'drv2' and 'Frq2' will be applied.</p> <table border="1"> <tr> <td>0</td> <td>Run/Stop by Run/Stop key on the keypad</td> <td></td> </tr> <tr> <td>1</td> <td rowspan="2">Terminal operation</td> <td>FX: Motor Forward Run RX: Motor Reverse Run</td> </tr> <tr> <td>2</td> <td>FX: Run/Stop enable RX: Reverse rotation selection</td> </tr> <tr> <td>3</td> <td>RS485 Communication</td> <td></td> </tr> </table>	0	Run/Stop by Run/Stop key on the keypad		1	Terminal operation	FX: Motor Forward Run RX: Motor Reverse Run	2	FX: Run/Stop enable RX: Reverse rotation selection	3	RS485 Communication		NO
0	Run/Stop by Run/Stop key on the keypad																
1	Terminal operation	FX: Motor Forward Run RX: Motor Reverse Run															
2		FX: Run/Stop enable RX: Reverse rotation selection															
3	RS485 Communication																

¹ It is only displayed if one of the multi-function input terminals P1 – P8 (parameters I17 – I24) is set to '22 → 2° Setting – Drive mode 2 and Frequency setting mode 2'.

Parameter	Description	Range	Default value	Memory address	Function	Set during RUN		
Frq2 ²	Frequency setting mode 2	0 – 7	0	A10F	If one of the digital inputs ('I17' to 'I24') configured with option '22' is activated, the values set in parameters 'drv2' and 'Frq2' will be applied.		NO	
					0	Digital		Keypad setting 1
					1			Keypad setting 2
					2	Analogue		V1 Mode 1: -10 – +10V
					3			V1 Mode 2: 0 – +10V
					4			Terminal I: 0 – 20mA
					5			Terminal V1 Mode 1 setting + Terminal I
					6			Terminal V1 Mode 2 setting + Terminal I
7	RS485 Communication							
Frq3 ³	Frequency setting mode 3	0 – 7	0	A110			NO	
					0	Digital		Keypad setting 1
					1			Keypad setting 2
					2	Analogue		V1 Mode 1: -10 – +10V
					3			V1 Mode 2: 0 – +10V
					4			Terminal I: 0 – 20mA
					5			Terminal V1 Mode 1 setting + Terminal I
					6			Terminal V1 Mode 2 setting + Terminal I
7	RS485 Communication							

² It is only displayed if one of the multi-function input terminals P1 – P8 (parameters I17 – I24) is set to '22' → Setting – Drive mode 2 and Frequency setting mode 2'.

³ It is only displayed when one of the multi-function input terminals P1 – P8 (parameters I17 – I24) is set to '28' → Alternative reference source'.

Parameter	Description	Range	Default value	Memory address	Function	Set during RUN
rEF ⁴	PID Reference	0.0 – 100% or Engin. Units	0.0%	A111	Setting of the reference value for PID control. The value is set in % or engineering units according to the settings of the parameters '189' and '190'. Note: If '189' and '190' are set to the default values, this parameter is set in %.	YES
Fbk ⁴	PID Feedback	-	0.0%	A112	Visualization of the feedback value for PID control. The value is displayed in % or engineering units according to the settings of the parameters '189' and '190'. Note: If '189' and '190' are set to the default values, this parameter is displayed in %.	-

⁴ It is only displayed when 'H49 → PID control select' is set to '1 → PID control enabled'.

8.2. Function 1 group (F)

Parameter	Description	Range	Default value	Memory address	Function	Set during RUN	
F0	Parameter jump	0 – 99	0	-	Parameter selection to jump	YES	
F1	Prevention of motor rotation direction	0 – 2	0	A201	0	Forward and Reverse Run enabled.	NO
					1	Forward Run disabled.	
					2	Reverse Run disabled.	
F2	Acceleration pattern	0 – 1	0	A202	0	Linear	NO
F3	Deceleration pattern			A203	1	S – Curve	
F4	Stop mode	0 – 3	0	A204	0	Decelerate to stop.	NO
					1	DC Brake to stop (DC current injection).	
					2	Free run to stop (motor will stop by inertia).	
					3	Power Braking Stop. It is used to prevent the drive from 'OVT' trip (Over voltage) when deceleration or stopping are made using regeneration braking power.	
F8 ⁵	DC Brake start frequency	0.00 – 60Hz	5.00Hz	A208	Setting of the frequency from which the inverter will start to inject DC current during deceleration. It cannot be set below 'F23 → Start frequency'.	NO	
F9 ⁵	DC current application delay time	0.1 – 60 sec	0.1 sec	A209	When DC brake frequency is reached, the inverter holds the output for the set time before starting DC current injection to stop.	NO	

⁵ It is only displayed when 'F4 → Stop mode' is set to '1 → DC brake to stop'.

Parameter	Description	Range	Default value	Memory address	Function	Set during RUN
F10 ⁶	DC current level for DC brake	0 – 200%	50%	A20A	It sets DC current level applied to the motor during 'DC brake'. The value is set in percentage of 'H33 → Motor rated current'.	NO
F11 ⁶	DC current application time	0.0 – 60 sec	1.0 sec	A20B	During this time, the inverter applies DC current injection during 'DC brake' operation.	NO
F12	DC current level before starting	0 – 200%	50%	A20C	Sets DC current level applied to the motor before the inverter starts. If 'F12' is set to '0', 'DC start' is disable. The value is set in percentage of 'H33 → Motor rated current'. If set value is greater than the value of 'H33', motor may get overheating.	NO
F13	DC current application time before starting	0.0 – 60 sec	0 sec	A20D	During this time, DC current is applied before starting motor acceleration. If 'F13' is set to '0', 'DC start' is disabled.	NO
F14	Time for magnetizing a motor	0.0 – 60 sec	1.0 sec	A20E	With this parameter the current is applied to the motor during the set time, before motor accelerates during Sensorless vector control. The current value is set in 'H34 → No load motor current'.	NO
F20	Jog frequency	0.00 – 400Hz	10.00Hz	A214	In this parameter, the reference frequency for jog frequency operation is set. This value cannot be set above 'F21 → Maximum frequency'.	NO

⁶ It is only displayed when 'F4 → Stop mode' is set to '1 → DC brake to stop'.

Parameter	Description	Range	Default value	Memory address	Function	Set during RUN
F21 ⁷	Maximum frequency	40.00 – 400Hz	50.00Hz	A215	This parameter sets the highest frequency the inverter can output. It is the reference frequency for acceleration/deceleration (See 'H70 → Frequency reference for accel/decel'). Caution: Any frequency cannot be set above Maximum frequency except Base frequency.	NO
F22	Base frequency	30.00 – 400Hz	50.00Hz	A216	The inverter outputs its rated voltage to the motor at this frequency (see motor nameplate).	NO
F23	Start frequency	0.10 – 10Hz	0.50Hz	A217	The inverter starts to output its voltage at this frequency. It is the low limit of frequency.	NO
F24	Frequency limits selection	0 – 1	0	A218	This parameter sets high and low limit of run frequency.	NO
F25 ⁸	High frequency limit	0.00 – 400Hz	50.00Hz	A219	This parameter sets high limit of the run frequency. It cannot be set above 'F21 → Maximum frequency'.	NO
F26 ⁸	Low frequency limit	0.10 – 400Hz	0.50Hz	A21A	This parameter sets low limit of the run frequency. It cannot be set above 'F25 → High frequency limit' and below 'F23 → Start frequency'.	NO

⁷ If 'H40 → Stop mode' is set to '3 → Sensorless open loop vector control', Maximum frequency is settable up to 300Hz.

⁸ It is only displayed when 'F24 → Frequency limits selection' is set to '1 → Frequency limit settings enabled'.

Parameter	Description	Range	Default value	Memory address	Function	Set during RUN	
F27	Torque boost selection	0 – 1	0	A21B	0	Manual torque boost. Settable in two rotation motor directions separately, in 'F28 → Torque boost in forward direction' and in 'F29 → Torque boost in reverse direction'.	NO
					1	Auto torque boost. The inverter calculates automatically the torque boost based on motor parameters and supplies the corresponding voltage level.	
F28	Torque boost in forward direction	0 – 15%	2%	A21C	This parameter sets the amount of torque boost applied to a motor during forward run. It is set in percentage of maximum output voltage.	NO	
F29	Torque boost in reverse direction		2%	A21D	This parameter sets the amount of torque boost applied to a motor during reverse run. It is set in percentage of maximum output voltage.	NO	
F30	V/F Pattern	0 – 2	0	A21E	0	Linear, for constant torque applications.	NO
					1	Square, for variable torque applications.	
					2	User V/F, settable by user for special applications.	

Parameter	Description	Range	Default value	Memory address	Function	Set during RUN
F31 ⁹	User V/F frequency 1	0.00 – 400Hz	12.50Hz	A21F	User can customize Voltage/Frequency pattern. It cannot be set above 'F21 → Maximum frequency'. The value of voltage is set in percentage of 'H70 → Motor rated voltage'. The values of the lower-numbered parameters cannot be set above those of higher-numbered.	NO
F32 ⁹	User V/F voltage 1	0 – 100%	25%	A220		NO
F33 ⁹	User V/F frequency 2	0.00 – 400Hz	25.00Hz	A221		NO
F34 ⁹	User V/F voltage 2	0 – 100%	50%	A222		NO
F35 ⁹	User V/F frequency 3	0.00 – 400Hz	37.50Hz	A223		NO
F36 ⁹	User V/F voltage 3	0 – 100%	75%	A224		NO
F37 ⁹	User V/F frequency 4	0.00 – 400Hz	50.00Hz	A225		NO
F38 ⁹	User V/F voltage 4	0 – 100%	100%	A226		NO
F39	Output voltage setting	40 – 110%	100%	A227	This parameter sets the value of output voltage. The set value is a % of input voltage.	NO
F40	Energy saving level	0 – 30%	0%	A228	The inverter decreases output voltage according to this setting, after accelerating until reaching reference frequency.	YES
F50	Selection of Electronic thermal protection	0 – 1	0	A232	This parameter protects the motor from possible overheating. The inverter trips when the protect function is active.	YES

⁹ It is available when parameter 'F30 → V/F Pattern' is set to '2 → User V/F'.

Parameter	Description	Range	Default value	Memory address	Function	Set during RUN
F51 ¹⁰	Level of Electronic thermal protection for 1 minute	50 – 200%	150%	A233	It allows setting set the current value from which the inverter decides on the motor is overheated. The set value is the percentage of 'H33 → Motor rated current'. It cannot be set below 'F52 → Level of Electronic thermal protection for continuous'.	YES
F52 ¹⁰	Level of Electronic thermal protection for continuous	50 – 150%	100%	A234	It allows setting the current value from which the inverter can operate in continuous. This value cannot be set higher than the value of 'F51 → Level of Electronic thermal protection for 1 minute'.	YES
F53 ¹⁰	Motor cooling mode	0 – 1	0	A235	0 Auto-cooling: Standard motor having cooling fan directly connected to the shaft.	YES
					1 Forced cooling: Separated motor to power a cooling fan is used.	
F54	Overload warning level	30 – 150%	150%	A236	This parameter sets the current value to generate an alarm signal at a relay or multi-function output terminal (See 'I54 → Multi-function output terminal configuration', 'I55 → Multi-function relay select'). The set value is a percentage of 'H33 → Motor rated current'.	YES
F55	Overload warning time	0 – 30 sec	10 sec	A237	It sets the time through which the current has to be current value set as overload current level to generate an alarm signal.	YES
F56	Overload trip selection	0 – 1	1	A238	This parameter turns off the inverter output when motor is overloaded.	YES

¹⁰ Set 'F50 → Selection of Electronic thermal protection' to '1 → Electronic thermal protection enabled' to display this parameter.

Parameter	Description	Range	Default value	Memory address	Function	Set during RUN																																								
F57	Overload trip level	30 – 200%	180%	A239	With this parameter the overload current value is set to generate a trip protecting motor and inverter. The value is a percentage of the value of 'H33 → Motor rated current'.	YES																																								
F58	Overload trip time	0 – 60 sec	60 sec	A23A	Setting of the time which will have to elapse with the inverter current level above the value set in 'F57 → Overload trip level' to generate its trip.	YES																																								
F59	Stall prevention mode	0 – 7	0	A23B	It allows setting the current dynamic limitation during acceleration, deceleration and steady status. <table border="1" data-bbox="567 546 860 856"> <thead> <tr> <th></th> <th>During Decel.</th> <th>During steady status</th> <th>During Accel.</th> </tr> <tr> <th></th> <th>Bit 2</th> <th>Bit 1</th> <th>Bit 0</th> </tr> </thead> <tbody> <tr> <td>0</td> <td>-</td> <td>-</td> <td>-</td> </tr> <tr> <td>1</td> <td>-</td> <td>-</td> <td>✓</td> </tr> <tr> <td>2</td> <td>-</td> <td>✓</td> <td>-</td> </tr> <tr> <td>3</td> <td>-</td> <td>✓</td> <td>✓</td> </tr> <tr> <td>4</td> <td>✓</td> <td>-</td> <td>-</td> </tr> <tr> <td>5</td> <td>✓</td> <td>-</td> <td>✓</td> </tr> <tr> <td>6</td> <td>✓</td> <td>✓</td> <td>-</td> </tr> <tr> <td>7</td> <td>✓</td> <td>✓</td> <td>✓</td> </tr> </tbody> </table>		During Decel.	During steady status	During Accel.		Bit 2	Bit 1	Bit 0	0	-	-	-	1	-	-	✓	2	-	✓	-	3	-	✓	✓	4	✓	-	-	5	✓	-	✓	6	✓	✓	-	7	✓	✓	✓	NO
	During Decel.	During steady status	During Accel.																																											
	Bit 2	Bit 1	Bit 0																																											
0	-	-	-																																											
1	-	-	✓																																											
2	-	✓	-																																											
3	-	✓	✓																																											
4	✓	-	-																																											
5	✓	-	✓																																											
6	✓	✓	-																																											
7	✓	✓	✓																																											
F60	Stall prevention level	30 – 200%	150%	A23C	In this parameter, the user sets the current level to activate limitation current function during deceleration, acceleration and steady status, according to the setting of 'F59'. The set value is a percentage of the value of 'H33 → Motor rated current'.	NO																																								

Parameter	Description	Range	Default value	Memory address	Function	Set during RUN				
F61*	Voltage limit select when stall prevent. mode during decel.	0 – 1	0	A23D	During deceleration in stall prevention operation mode, if the user wants to limit the output voltage, user should set this parameter to '1'.	NO				
F63	Save Up/Down frequency select	0 – 1	0	A23F	<p>Defines if the inverter should memorize the reference frequency set by motorized potentiometer during Up/Down operation mode.</p> <table border="1"> <tr> <td>0</td> <td>NO</td> </tr> <tr> <td>1</td> <td>SI</td> </tr> </table> <p>If this parameter is set to '1', the reference value is saved in 'F64'. See 'Note' in parameter 'F65' to operate in Up/Down mode.</p>	0	NO	1	SI	NO
0	NO									
1	SI									
F64 ¹¹	Saved frequency in Up/Down mode	0.00 – 400Hz	-	A240	When parameter 'F63' is set to '1', this parameter saved the value of the reference frequency before the drive stops or decelerates. See 'Note' in parameter 'F65' to operate in Up/Down mode.	NO				

* It is only displayed if bit 2 of parameter 'F59 → Stall prevention mode' is set to '1'.

¹¹ This parameter is only displayed if 'F63 → Up/Down Save' is set to '1 → YES'.

Parameter	Description	Range	Default value	Memory address	Function	Set during RUN						
F65	Up/Down mode selection	0 – 2	0	A241	<p>There are three available options for the Up/Down operation mode:</p> <table border="1"> <tr> <td>0</td> <td>The reference frequency is increased up to maximum frequency or decreased down to minimum frequency respecting high and low frequency limits.</td> </tr> <tr> <td>1</td> <td>The frequency value is increased or decreased by steps (step frequency is set in F66) when Up or Down input is activated.</td> </tr> <tr> <td>2</td> <td>Combination of options '0' and '1'. First, it operates in mode '1' and if the activation time for Up or Down input is higher than 3s, it will operate in mode '0' until the input is deactivated.</td> </tr> </table> <p>Note: In order to operate in Up/Down mode - Select option '8' in parameter 'Frq'. - Configure two digital inputs (P1 – P8) with options '15 → Up frequency' and '16 → Down frequency' each one.</p>	0	The reference frequency is increased up to maximum frequency or decreased down to minimum frequency respecting high and low frequency limits.	1	The frequency value is increased or decreased by steps (step frequency is set in F66) when Up or Down input is activated.	2	Combination of options '0' and '1'. First, it operates in mode '1' and if the activation time for Up or Down input is higher than 3s, it will operate in mode '0' until the input is deactivated.	NO
0	The reference frequency is increased up to maximum frequency or decreased down to minimum frequency respecting high and low frequency limits.											
1	The frequency value is increased or decreased by steps (step frequency is set in F66) when Up or Down input is activated.											
2	Combination of options '0' and '1'. First, it operates in mode '1' and if the activation time for Up or Down input is higher than 3s, it will operate in mode '0' until the input is deactivated.											
F66	Step frequency in Up/Down mode	0.00 – 400Hz	0.00Hz	A242	<p>In case of setting parameter 'F65' to '1' or '2', the reference frequency is increased or decreased step-by-step, every time the Up or Down input is activated. These frequency steps are set in this parameter. See 'Note' in parameter 'F65' to operate in Up/Down mode.</p>	NO						

Parameter	Description	Range	Default value	Memory address	Function	Set during RUN	
F70	Draw run mode selection (steady voltage)	0 – 3	0	A246	It is a kind of Open Loop voltage control that uses the speed difference of motor to keep voltage steady changing the output frequency from reference frequency.	NO	
					0		Draw mode disabled.
					1		Draw run mode. V1 input (0 – 10V).
					2		Draw run mode. I input (0 – 20mA).
					3		Draw run mode. V1 or NV input (-10V to +10V).
F71	Output frequency variation rate in Draw mode	0.0 – 100%	0.0%	A247	Variation of the output frequency applied in Draw mode (according to the setting of 'F70') is based on this rate.	YES	

8.3. Function 2 group (H)

Parameter	Description	Range	Default value	Memory address	Function	Set during RUN
H0	Parameter jump	0 – 99	1	A300	Parameter selection to jump.	YES
H1	Fault history 1	-	nOn	A301	It stores information on the types of faults, the frequency, the current and the acceleration/deceleration condition at the time of fault. The latest fault is automatically stored in the 'H1 → Fault history 1'.	-
H2	Fault history 2	-	nOn	A302		-
H3	Fault history 3	-	nOn	A303		-
H4	Fault history 4	-	nOn	A304		-
H5	Fault history 5	-	nOn	A305		-
H6	Reset fault history	0 – 1	0	A306	It allows clearing the fault history stored from 'H1' to 'H5'.	YES
H7	Dwell frequency	0.10 – 400Hz	5.00Hz	A307	It allows setting the previous speed with which inverter operates before applying the acceleration ramp, after command run is received (Dwell function). Dwell frequency can be set within the range of the values of 'F21 → Maximum frequency' and 'F23 → Start frequency'.	NO
H8	Dwell time	0.0 – 10 sec	0.0 sec	A308	It allows setting a time to the inverter operates with a stipulated speed before applying the acceleration ramp (Dwell function).	NO

Parameter	Description	Range	Default value	Memory address	Function	Set during RUN
H10	Selection of resonant frequencies	0 – 1	0	A30A	It allows setting up to three frequency ranges which will be avoided when the inverter operates at steady status. During acceleration and deceleration the ranges before mentioned are not considered. If speed reference was included in one of those ranges, the inverter operates with the minimum speed of that range. It allows preventing resonances and vibrations on the structure of the machine.	NO
H11 ¹²	Low resonant frequency range 1	0.10 – 400Hz	10.00Hz	A30B	It sets low/high resonant frequency of the ranges 1, 2, or 3 to avoid at steady status. Operation frequency cannot be set to a value included into those ranges, that is, it cannot be set to a value included between 'H11' and 'H12', between 'H13' and 'H14', and between 'H15' and 'H16'. The frequency values of the low numbered parameters cannot be set above those of the high numbered ones. Settable within the range of 'F21 → Maximum frequency' and 'F23 → Start frequency'.	NO
H12 ¹²	High resonant frequency range 1		15.00Hz	A30C		NO
H13 ¹²	Low resonant frequency range 2		20.00Hz	A30D		NO
H14 ¹²	High resonant frequency range 2		25.00Hz	A30E		NO
H15 ¹²	Low resonant frequency range 3		30.00Hz	A30F		NO
H16 ¹²	High resonant frequency range 3		35.00Hz	A310		NO

¹² It is only displayed when 'H10 → Selection of resonant frequencies' is set to '1 → Setting of resonant frequency ranges enabled'.

Parameter	Description	Range	Default value	Memory address	Function	Set during RUN
H17 ¹³	S-Curve start	1 – 100%	40%	A311	It allows setting the start of the S–Curve selected in acceleration pattern. If it is set higher, linear zone gets smaller.	NO
H18 ¹³	S-Curve end	1 – 100%	40%	A312	It allows setting the end of the S–Curve selected in deceleration pattern. If it is set higher, linear zone gets smaller.	NO
H19	Selection of input/output phase loss protection	0 – 3	0	A313	0 Disabled.	YES
					1 Output phase protection.	
					2 Input phase protection.	
					3 Input/output phase protection.	
H20	Restart after power supply fault	0 – 1	0	A314	Allows the inverter to restart automatically after a power supply fault occurs and restore it again. This parameter is activated when 'drv → Drive mode' is set to '1 or 2 → Terminal operation'. Motor starts acceleration after AC power is applied while FX or RX terminal is ON.	YES
H21	Restart after fault reset	0 – 1	0	A315	Allows the inverter to restart automatically after reset signal has been received after a fault occurs. This parameter is activated when 'drv → Drive mode' is set to '1 or 2 → Terminal operation'. Motor accelerates after the fault condition is reset while FX or RX terminal is ON.	YES

¹³ H17', 'H18' are used when 'F2 → Acceleration pattern', 'F3 → Deceleration pattern' are set to '1 → S–Curve' respectively.

Parameter	Description	Range	Default value	Memory address	Function	Set during RUN																																																																																										
H22 ¹⁴	Speed search function	0 – 15	0	A316	<p>This function allows restarting automatically after a fault occurs or after a power supply loss without waiting for motor stops.</p> <p>Case 1: Restart after power supply fault. Case 2: Restart after instant power failure. Case 3: Speed search active after fault reset. Case 4: Normal acceleration.</p> <table border="1"> <thead> <tr> <th></th> <th>Case 1</th> <th>Case 2</th> <th>Case 3</th> <th>Case 4</th> </tr> <tr> <th></th> <th>Bit 3</th> <th>Bit 2</th> <th>Bit 1</th> <th>Bit 0</th> </tr> </thead> <tbody> <tr><td>0</td><td>-</td><td>-</td><td>-</td><td>-</td></tr> <tr><td>1</td><td>-</td><td>-</td><td>-</td><td>✓</td></tr> <tr><td>2</td><td>-</td><td>-</td><td>✓</td><td>-</td></tr> <tr><td>3</td><td>-</td><td>-</td><td>✓</td><td>✓</td></tr> <tr><td>4</td><td>-</td><td>✓</td><td>-</td><td>-</td></tr> <tr><td>5</td><td>-</td><td>✓</td><td>-</td><td>✓</td></tr> <tr><td>6</td><td>-</td><td>✓</td><td>✓</td><td>-</td></tr> <tr><td>7</td><td>-</td><td>✓</td><td>✓</td><td>✓</td></tr> <tr><td>8</td><td>✓</td><td>-</td><td>-</td><td>-</td></tr> <tr><td>9</td><td>✓</td><td>-</td><td>-</td><td>✓</td></tr> <tr><td>10</td><td>✓</td><td>-</td><td>✓</td><td>-</td></tr> <tr><td>11</td><td>✓</td><td>-</td><td>✓</td><td>✓</td></tr> <tr><td>12</td><td>✓</td><td>✓</td><td>-</td><td>-</td></tr> <tr><td>13</td><td>✓</td><td>✓</td><td>-</td><td>✓</td></tr> <tr><td>14</td><td>✓</td><td>✓</td><td>✓</td><td>-</td></tr> <tr><td>15</td><td>✓</td><td>✓</td><td>✓</td><td>✓</td></tr> </tbody> </table>		Case 1	Case 2	Case 3	Case 4		Bit 3	Bit 2	Bit 1	Bit 0	0	-	-	-	-	1	-	-	-	✓	2	-	-	✓	-	3	-	-	✓	✓	4	-	✓	-	-	5	-	✓	-	✓	6	-	✓	✓	-	7	-	✓	✓	✓	8	✓	-	-	-	9	✓	-	-	✓	10	✓	-	✓	-	11	✓	-	✓	✓	12	✓	✓	-	-	13	✓	✓	-	✓	14	✓	✓	✓	-	15	✓	✓	✓	✓	YES
	Case 1	Case 2	Case 3	Case 4																																																																																												
	Bit 3	Bit 2	Bit 1	Bit 0																																																																																												
0	-	-	-	-																																																																																												
1	-	-	-	✓																																																																																												
2	-	-	✓	-																																																																																												
3	-	-	✓	✓																																																																																												
4	-	✓	-	-																																																																																												
5	-	✓	-	✓																																																																																												
6	-	✓	✓	-																																																																																												
7	-	✓	✓	✓																																																																																												
8	✓	-	-	-																																																																																												
9	✓	-	-	✓																																																																																												
10	✓	-	✓	-																																																																																												
11	✓	-	✓	✓																																																																																												
12	✓	✓	-	-																																																																																												
13	✓	✓	-	✓																																																																																												
14	✓	✓	✓	-																																																																																												
15	✓	✓	✓	✓																																																																																												
H23	Current level for Speed search	80 – 200%	100%	A317	<p>This parameter limits the amount of current during speed search. The set value is a percentage of 'H33 → Motor rated current'.</p>	YES																																																																																										
H24	P gain for Speed search	0 – 9999	100	A318	<p>It is the proportional gain which should be set considering the load inertia and the load torque.</p>	YES																																																																																										

¹⁴ '4 → 'Normal acceleration' has first priority. Even though this option is selected along with others bits, Inverter performs Speed search according to '4'.

Parameter	Description	Range	Default value	Memory address	Function	Set during RUN								
H25	I gain for Speed search	0 – 9999	200	A319	It is the integral gain which should be set considering the load inertia and the load torque.	YES								
H26	Tries of automatic fault resets (Auto-restart)	0 – 10	0	A31A	This function serves to the inverter restarts after a fault occurs. This parameter sets the number of restart tries. This function is deactivated if the restart tries is outnumbered. This function is active when 'drv → Drive mode' is set to '1 or 2 → Terminal operation'. Deactivated when some of the protection functions is active (OHT, LVT, EXT, HWT etc.).	YES								
H27	Time between tries of automatic fault resets	0.0 – 60 sec	1.0 sec	A31B	This parameter sets the wait time between an automatic fault reset and the next one.	YES								
H30	Motor power setting	0.2 – 7.5kW	*	A31E	<table border="1"> <tbody> <tr> <td>0.2</td> <td>0.2kW</td> </tr> <tr> <td>"</td> <td>"</td> </tr> <tr> <td>5.5</td> <td>5.5kW</td> </tr> <tr> <td>7.5</td> <td>7.5kW</td> </tr> </tbody> </table>	0.2	0.2kW	"	"	5.5	5.5kW	7.5	7.5kW	NO
0.2	0.2kW													
"	"													
5.5	5.5kW													
7.5	7.5kW													
H31	Selection of number of motor poles	2 – 12	4	A31F	Sets the number of poles of the motor which is used. This setting is displayed by 'rPM → Motor RPM' in Drive group.	NO								
H32	Rated slip frequency	0 – 10Hz	*	A320	$f_s = f_r - \left(\frac{rpm \times P}{120} \right)$ Where, f_s = Rated slip frequency f_r = Rated frequency rpm = Motor RPM P = Number of motor poles	NO								
H33	Motor rated current	0.5 – 50A	*	A321	Motor rated current which appears on the motor nameplate is entered in this parameter.	NO								

* Depending on the motor will be used.

Parameter	Description	Range	Default value	Memory address	Function	Set during RUN								
H34	No load motor current	0.1 – 20A	*	A322	Enter the current value detected when the motor is rotating in rated rpm after the load connected to the motor shaft is removed.	NO								
H36	Motor efficiency	50 – 100%	*	A324	Enter the motor efficiency (see motor nameplate).	NO								
H37	Load inertia rate	0 – 2	0	A325	Select one of the following according to motor inertia. <table border="1"> <tr> <td>0</td> <td>Less than 10 times.</td> </tr> <tr> <td>1</td> <td>10 times.</td> </tr> <tr> <td>2</td> <td>More than 10 times.</td> </tr> </table>	0	Less than 10 times.	1	10 times.	2	More than 10 times.	NO		
0	Less than 10 times.													
1	10 times.													
2	More than 10 times.													
H39	Setting of Carrier frequency (commutation frequency)	1 – 15kHz	3kHz	A327	It allows setting carrier frequency depending on the frame of the inverter. This parameter affects the audible sound of the motor, noise emission from the inverter, inverter temp, and leakage current.	YES								
H40	Selection of Control mode	0 – 3	0	A328	<table border="1"> <tr> <td>0</td> <td>Volts/Frequency control.</td> </tr> <tr> <td>1</td> <td>Slip Compensation control.</td> </tr> <tr> <td>2</td> <td>- (Not selectable option).</td> </tr> <tr> <td>3</td> <td>Sensorless vector control.</td> </tr> </table>	0	Volts/Frequency control.	1	Slip Compensation control.	2	- (Not selectable option).	3	Sensorless vector control.	NO
0	Volts/Frequency control.													
1	Slip Compensation control.													
2	- (Not selectable option).													
3	Sensorless vector control.													
H41	Auto-tuning of motor parameters	0 – 1	0	A329	It allows measuring automatically all necessary parameters to operate in control mode selected. If this parameter is set to '1', parameters 'H42 → Stator resistance' and 'H44 → Leakage inductance' are measured.	NO								
H42	Stator resistance (Rs)	0 – 28Ω	-	A32A	Calculation of the stator resistance depending on the motor capacity.	NO								
H44	Leakage inductance (Lσ)	0.0 – 300.0 mH	-	A32C	Calculation of the leakage inductance depending on the motor capacity.	NO								

* Depending on the motor will be used.

Parameter	Description	Range	Default value	Memory address	Function	Set during RUN						
H45 ¹⁵	Sensorless P gain	0 – 32767	1000	A32D	This parameter sets the value of P gain which will be used in sensorless vector control. Very high value supplies a very fast response, but the system can become unstable. Set an appropriate value for your application.	YES						
H46 ¹⁵	Sensorless I gain		100	A32E	This parameter sets the value of I gain which will be used in sensorless vector control. Very low value supplies more stable and lower response, but the inverter can turn off the output during speed control. Set an appropriate value for your application.	YES						
H47 ¹⁵	Sensorless torque limit	100.0 – 220%	180.0%	A32F	It allows setting the output torque limit in open loop control mode (Sensorless).	NO						
H48	PWM mode selection	0 – 1	0	A330	Heat loss and leakage current from the inverter can be reduced according to the ratio of the load, when the user selects 2-phase PWM mode. It has more noise in comparison to normal PWM mode. <table border="1" style="width: 100%; border-collapse: collapse;"> <tr> <td style="width: 20px; text-align: center;">0</td> <td>Normal PWM mode.</td> </tr> <tr> <td style="width: 20px; text-align: center;">1</td> <td>2-phase PWM mode.</td> </tr> </table>	0	Normal PWM mode.	1	2-phase PWM mode.	NO		
0	Normal PWM mode.											
1	2-phase PWM mode.											
H49	PID control selection	0 – 1	0	A331	It allows selecting the use of the PID control. <table border="1" style="width: 100%; border-collapse: collapse;"> <tr> <td style="width: 20px; text-align: center;">0</td> <td>PID control disabled.</td> </tr> <tr> <td style="width: 20px; text-align: center;">1</td> <td>PID control enabled.</td> </tr> </table>	0	PID control disabled.	1	PID control enabled.	NO		
0	PID control disabled.											
1	PID control enabled.											
H50 ¹⁶	PID Feedback setting	0 – 2	0	A332	<table border="1" style="width: 100%; border-collapse: collapse;"> <tr> <td style="width: 20px; text-align: center;">0</td> <td>Terminal I input (0 – 20mA)</td> </tr> <tr> <td style="width: 20px; text-align: center;">1</td> <td>Terminal V1 input (0 – 10V)</td> </tr> <tr> <td style="width: 20px; text-align: center;">2</td> <td>RS485 Communication</td> </tr> </table>	0	Terminal I input (0 – 20mA)	1	Terminal V1 input (0 – 10V)	2	RS485 Communication	NO
0	Terminal I input (0 – 20mA)											
1	Terminal V1 input (0 – 10V)											
2	RS485 Communication											

¹⁵ Set 'H40 → Selection of Control mode' to '3 → Sensorless Vector control' to display this parameter.

¹⁶ Set 'H49 → PID control selection' to '1 → Control PID enabled' to display this parameter.

Parameter	Description	Range	Default value	Memory address	Function	Set during RUN				
H51 ¹⁷	P gain for PID mode	0.0 – 999.9 %	300.0%	A333	These parameters allow setting the gains for the PID mode.	YES				
H52 ¹⁷	I gain (Integral time) for PID mode	0.10 – 32 sec	1.00 sec	A334		YES				
H53 ¹⁷	D gain (Differential time) for PID mode	0.00 – 30 sec	0.00 sec	A335		YES				
H54 ¹⁷	PID control mode selection	0 – 1	0	A336	<p>It allows selecting the PID control mode between two available options:</p> <table border="1"> <tr> <td>0</td> <td>Normal PID control.</td> </tr> <tr> <td>1</td> <td>Process PID control. It considers the reference frequency (parameter '0.00' in DRV group) introduced by any source (parameters 'Frq'/Frq2'), except for motorized potentiometer (Up/Down mode).</td> </tr> </table>	0	Normal PID control.	1	Process PID control. It considers the reference frequency (parameter '0.00' in DRV group) introduced by any source (parameters 'Frq'/Frq2'), except for motorized potentiometer (Up/Down mode).	NO
0	Normal PID control.									
1	Process PID control. It considers the reference frequency (parameter '0.00' in DRV group) introduced by any source (parameters 'Frq'/Frq2'), except for motorized potentiometer (Up/Down mode).									
H55 ¹⁷	High limit of output frequency in PID mode	0.10 – 400Hz	50.00Hz	A337	Setting of the maximum value of the output frequency in PID mode. The value is settable within the range of 'F21 → Maximum frequency' and 'F23 → Start frequency'.	YES				
H56 ¹⁷	Low limit of output frequency in PID mode	0.10 – 400Hz	0.50Hz	A338	Setting of the minimum value of the output frequency in PID mode. The value is settable within the range of 'F21 → Maximum frequency' and 'F23 → Start frequency'.	YES				

¹⁷ Set 'H49 → PID control selection' to '1 → Control PID enabled' to display this parameter.

Parameter	Description	Range	Default value	Memory address	Function	Set during RUN										
H57 ¹⁸	PID reference mode setting	0 – 4	0	A339	It allows selecting the source for introducing PID reference value, indicated in parameter 'rEF' of DRV group. <table border="1"> <tr><td>0</td><td>Keypad setting 1.</td></tr> <tr><td>1</td><td>Keypad setting 2.</td></tr> <tr><td>2</td><td>V1 terminal setting 2: 0 – 10V</td></tr> <tr><td>3</td><td>I terminal setting: 0 – 20mA</td></tr> <tr><td>4</td><td>Setting as a RS485 communication.</td></tr> </table>	0	Keypad setting 1.	1	Keypad setting 2.	2	V1 terminal setting 2: 0 – 10V	3	I terminal setting: 0 – 20mA	4	Setting as a RS485 communication.	NO
0	Keypad setting 1.															
1	Keypad setting 2.															
2	V1 terminal setting 2: 0 – 10V															
3	I terminal setting: 0 – 20mA															
4	Setting as a RS485 communication.															
H59 ¹⁸	Output inversion in PID mode	0 – 1	0	A33B	<table border="1"> <tr><td>0</td><td>Normal</td></tr> <tr><td>1</td><td>Inversion</td></tr> </table>	0	Normal	1	Inversion	NO						
0	Normal															
1	Inversion															
H60	Selection of self-diagnostic	0 – 3	0	A33C	To activate this function is necessary, as well as this parameter setting, configure one of the multi-function digital inputs (I17 – I24) a '20 → Self-diagnostic function'. <table border="1"> <tr><td>0</td><td>Self-diagnostic disabled.</td></tr> <tr><td>1</td><td>IGBT fault/Ground fault.</td></tr> <tr><td>2</td><td>Output phase loss/Ground fault.</td></tr> <tr><td>3</td><td>Ground fault.</td></tr> </table>	0	Self-diagnostic disabled.	1	IGBT fault/Ground fault.	2	Output phase loss/Ground fault.	3	Ground fault.	NO		
0	Self-diagnostic disabled.															
1	IGBT fault/Ground fault.															
2	Output phase loss/Ground fault.															
3	Ground fault.															
H61	Sleep delay time	0.0 – 2000 sec	60.0 sec	A33D	This parameter fixes the time that the inverter waits for it before activating sleep mode.	NO										
H62	Sleep frequency	0.00 – 400Hz	0.0Hz	A33E	This parameter sets the value of sleep frequency.	YES										
H63	Wake up level in Sleep mode	0.0 – 50%	2.0%	A33F	When the inverter is in Sleep mode, and the feedback decreases regarding the order in an equal or higher percentage of the value set here, the inverter activates the output to the motor again.	YES										

¹⁸ Set 'H49 → PID control selection' to '1 → Control PID enabled' to display this parameter.

Parameter	Description	Range	Default value	Memory address	Function	Set during RUN				
H64	KEB operation selection (Kinetic Energy Buffering)	0 – 1	0	A340	It allows enabling KEB (Kinetic Energy Buffering), by which, when input power is interrupted, the inverter does not stop and decelerates, by controlling the output frequency during the time of power failure. For this, the energy occurred from the motor load is used to keep DC Bus voltage. When input power is restored, the inverter accelerates to reach its normal operation again. <table border="1"> <tr> <td>0</td> <td>KEB operation disabled.</td> </tr> <tr> <td>1</td> <td>KEB operation enabled.</td> </tr> </table>	0	KEB operation disabled.	1	KEB operation enabled.	NO
0	KEB operation disabled.									
1	KEB operation enabled.									
H65 ¹⁹	KEB operation start level	110.0 – 140%	125.0%	A341	It sets DC Bus voltage level to activate KEB operation.	NO				
H66 ¹⁹	KEB operation stop level	110.0 – 145%	130.0%	A342	It sets DC Bus voltage level to deactivate KEB operation.	NO				
H67 ¹⁹	KEB operation gain	1 – 20000	1000	A343	It allows setting the gain for KEB operation.	NO				
H69	Frequency of accel/decel change	0.00 – 400Hz	0Hz	A345	This parameter sets the frequency level from which accel/decel ramps applied to the inverter will be changed. When reference frequency is above the frequency set here, the applied accel/decel ramps will be the ramps set in ACC and dEC respectively. And, when the frequency is lower, the ramps applied are set in I34 and I35.	NO				
H70	Reference frequency for accel/decel	0 – 1	0	A346	<table border="1"> <tr> <td>0</td> <td>Based on Maximum frequency (F21).</td> </tr> <tr> <td>1</td> <td>Based on Delta frequency.</td> </tr> </table>	0	Based on Maximum frequency (F21).	1	Based on Delta frequency.	NO
0	Based on Maximum frequency (F21).									
1	Based on Delta frequency.									

¹⁹ Set 'H64 → KEB operation selection' to '1 → KEB operation enabled' to display this parameter.

Parameter	Description	Range	Default value	Memory address	Function	Set during RUN																																				
H71	Accel/Decel time scale	0 – 2	1	A347	<table border="1"> <tr><td>0</td><td>Unit of time: 0.01 sec.</td></tr> <tr><td>1</td><td>Unit of time: 0.1 sec.</td></tr> <tr><td>2</td><td>Unit of time: 1 sec.</td></tr> </table>	0	Unit of time: 0.01 sec.	1	Unit of time: 0.1 sec.	2	Unit of time: 1 sec.	YES																														
0	Unit of time: 0.01 sec.																																									
1	Unit of time: 0.1 sec.																																									
2	Unit of time: 1 sec.																																									
H72	Power on display (first screen)	0 – 17	0	A348	<p>According to the code entered here, a different parameter will be displayed when the inverter loses the power supply and recovers it again.</p> <table border="1"> <tr><td>0</td><td>Reference frequency.</td></tr> <tr><td>1</td><td>Acceleration time.</td></tr> <tr><td>2</td><td>Deceleration time.</td></tr> <tr><td>3</td><td>Drive mode.</td></tr> <tr><td>4</td><td>Frequency mode.</td></tr> <tr><td>5</td><td>Step freq.-1.</td></tr> <tr><td>6</td><td>Step freq.-2.</td></tr> <tr><td>7</td><td>Step freq.-3.</td></tr> <tr><td>8</td><td>Output current.</td></tr> <tr><td>9</td><td>Motor Rpm.</td></tr> <tr><td>10</td><td>Inverter DC Link voltage.</td></tr> <tr><td>11</td><td>Selection of user screen (H73).</td></tr> <tr><td>12</td><td>Fault display.</td></tr> <tr><td>13</td><td>Direction of motor rotation select.</td></tr> <tr><td>14</td><td>Output current 2</td></tr> <tr><td>15</td><td>Motor Rpm 2.</td></tr> <tr><td>16</td><td>Inverter DC Link voltage 2.</td></tr> <tr><td>17</td><td>User display select 2.</td></tr> </table>	0	Reference frequency.	1	Acceleration time.	2	Deceleration time.	3	Drive mode.	4	Frequency mode.	5	Step freq.-1.	6	Step freq.-2.	7	Step freq.-3.	8	Output current.	9	Motor Rpm.	10	Inverter DC Link voltage.	11	Selection of user screen (H73).	12	Fault display.	13	Direction of motor rotation select.	14	Output current 2	15	Motor Rpm 2.	16	Inverter DC Link voltage 2.	17	User display select 2.	YES
0	Reference frequency.																																									
1	Acceleration time.																																									
2	Deceleration time.																																									
3	Drive mode.																																									
4	Frequency mode.																																									
5	Step freq.-1.																																									
6	Step freq.-2.																																									
7	Step freq.-3.																																									
8	Output current.																																									
9	Motor Rpm.																																									
10	Inverter DC Link voltage.																																									
11	Selection of user screen (H73).																																									
12	Fault display.																																									
13	Direction of motor rotation select.																																									
14	Output current 2																																									
15	Motor Rpm 2.																																									
16	Inverter DC Link voltage 2.																																									
17	User display select 2.																																									
H73	Selection of user screen	0 – 2	0	A349	<p>One of the following data can be monitored by 'vOL → Selection of user screen':</p> <table border="1"> <tr><td>0</td><td>Output voltage (V).</td></tr> <tr><td>1</td><td>Output power (kW).</td></tr> <tr><td>2</td><td>Torque (kgf · m).</td></tr> </table>	0	Output voltage (V).	1	Output power (kW).	2	Torque (kgf · m).	YES																														
0	Output voltage (V).																																									
1	Output power (kW).																																									
2	Torque (kgf · m).																																									
H74	Displaying of gain for motor rpm	1 – 1000%	100%	A34A	This parameter is used to change the motor speed display, from rotation speed (r/min) to mechanical speed (m/mi).	YES																																				

Parameter	Description	Range	Default value	Memory address	Function	Set during RUN				
H75	Selection of operation rate limit of dynamic brake resistor	0 – 1	0	A34B	<table border="1"> <tr> <td>0</td> <td>Unlimited.</td> </tr> <tr> <td>1</td> <td>Use dynamic brake resistor for the time set in 'H76'.</td> </tr> </table>	0	Unlimited.	1	Use dynamic brake resistor for the time set in 'H76'.	YES
0	Unlimited.									
1	Use dynamic brake resistor for the time set in 'H76'.									
H76	Operation rate of dynamic brake resistor	0 – 30%	10%	A34C	This parameter sets the percentage of the dynamic brake resistor value that is activated during one sequence of operation.	YES				
H77 ²⁰	Cooling fan control	0 – 1	0	A34D	<table border="1"> <tr> <td>0</td> <td>Always connected.</td> </tr> <tr> <td>1</td> <td>Active when its temp is higher than inverter protection limit temp. Activated only during operation when its temp is below that of inverter protection limit.</td> </tr> </table>	0	Always connected.	1	Active when its temp is higher than inverter protection limit temp. Activated only during operation when its temp is below that of inverter protection limit.	YES
0	Always connected.									
1	Active when its temp is higher than inverter protection limit temp. Activated only during operation when its temp is below that of inverter protection limit.									
H78	Selection of operation mode when cooling fan malfunctions	0 – 1	0	A34E	<table border="1"> <tr> <td>0</td> <td>Continuous operation when cooling fan malfunctions.</td> </tr> <tr> <td>1</td> <td>Operation stopped when cooling fan malfunctions.</td> </tr> </table>	0	Continuous operation when cooling fan malfunctions.	1	Operation stopped when cooling fan malfunctions.	YES
0	Continuous operation when cooling fan malfunctions.									
1	Operation stopped when cooling fan malfunctions.									
H79	Software Version	-	EU 2.x	A34F	This parameter displays the inverter software version.	-				

²⁰ Exception: Since SD25203/SD25301 this parameter is hidden.

Parameter	Description	Range	Default value	Memory address	Function	Set during RUN																							
H81 ²¹	Accel. time for second motor	0.0 – 6000 sec	5.0 sec	A351	Parameters settings for the second motor. Correspondence with the settable parameters of the first motor:	YES																							
H82 ²¹	Decel. time for second motor		10.0 sec	A352		YES																							
H83 ²¹	Base frequency for second motor	30.00 – 400Hz	50.00Hz	A353		NO																							
H84 ²¹	V/F Pattern for second motor	0 – 2	0	A354		NO																							
H85 ²¹	Forward torque boost for second motor	0 – 15%	5%	A355		<table border="1"> <thead> <tr> <th>2nd motor parameters settings</th> <th>1st motor parameters settings</th> </tr> </thead> <tbody> <tr> <td>H81</td> <td>ACC</td> </tr> <tr> <td>H82</td> <td>dEC</td> </tr> <tr> <td>H83</td> <td>F22</td> </tr> <tr> <td>H84</td> <td>F30</td> </tr> <tr> <td>H85</td> <td>F28</td> </tr> <tr> <td>H86</td> <td>F29</td> </tr> <tr> <td>H87</td> <td>F60</td> </tr> <tr> <td>H88</td> <td>F51</td> </tr> <tr> <td>H89</td> <td>F52</td> </tr> <tr> <td>H90</td> <td>H33</td> </tr> </tbody> </table>	2 nd motor parameters settings	1 st motor parameters settings	H81	ACC	H82	dEC	H83	F22	H84	F30	H85	F28	H86	F29	H87	F60	H88	F51	H89	F52	H90	H33	NO
2 nd motor parameters settings	1 st motor parameters settings																												
H81	ACC																												
H82	dEC																												
H83	F22																												
H84	F30																												
H85	F28																												
H86	F29																												
H87	F60																												
H88	F51																												
H89	F52																												
H90	H33																												
H86 ²¹	Reverse torque boost for second motor	5%	A356	NO																									
H87 ²¹	Stall prevention level for second motor	30 – 150%	150%	A357	NO																								
H88 ²¹	Electronic thermal protection for 1 minute for second motor	50 – 200%	150%	A358	Parameters descriptions referred to the first motor are valid for the same parameters refer to the second motor.	YES																							
H89 ²¹	Electronic thermal protection for continuous for second motor		100%	A359		YES																							
H90 ²¹	Motor rated current for second motor	0.1 – 50A	*	A35A	NO																								

²¹ It is only displayed if, at least, one of the multi-function digital inputs (I17 – I24) is set to '12 → Second motor select'.

* Depending on the motor will be used.

Parameter	Description	Range	Default value	Memory address	Function	Set during RUN	
H91 ²²	Parameters read	0 – 1	0	A35B	It copies the parameters from the inverter and save them into the remote keypad. For this, follow the next steps: 1. In 'H91', press 'Ent' key. 2. Select '1' and press 'Ent' key. While '1' is blinking, press 'Ent' key again. 3. 'rd' is displayed during a few seconds. After this, 'H91' is displayed again.	NO	
H92 ²²	Parameters write	0 – 1	0	A35C	It copies the parameters from the remote keypad and save them into the inverter. For this, follow the next steps: 1. In 'H92', press 'Ent' key. 2. Select '1' and press 'Ent' key. While '1' is blinking, press 'Ent' key again. 3. 'wr' is displayed during a few seconds. After this, 'H92' is displayed again.	NO	
H93	Parameters initialize	0 – 5	0	A35D	This parameter is used to initialize parameters back to the factory default value.	NO	
					0		-
					1		All parameter groups are initialized to factory default value.
					2		Only Drive group is initialized.
					3		Only Function 1 group is initialized.
					4		Only Function 2 group is initialized.
5	Only I/O group is initialized.						

²² It is only displayed when remote keypad is connected (option for read and write parameters).

Parameter	Description	Range	Default value	Memory address	Function	Set during RUN				
H94	Password register	0 – FFFF	0	A35E	<p>Password for 'H95 → Parameters lock'. It is set as Hexadecimal value.</p> <p>Note: To register a password for the first time: 1. In 'H94', press 'Ent' key twice. 2. Register the password (except '0') and press 'Ent' key (the value will blink). 3. Press 'Ent' key again to save the value and return to 'H94'.</p> <p>Note: To change the password, follow the next steps: 1. In 'H94', press 'Ent' key once. 2. Introduce the present password and press 'Ent' key again. 3. Introduce the new password and press 'Ent' key (the value will blink). 4. Press 'Ent' key again to save the value and return to 'H94'.</p>	YES				
H95	Parameters lock	0 – FFFF	0	A35F	<p>This parameter is able to lock or unlock parameters by typing password registered before in 'H94 → Password register'.</p> <table border="1" data-bbox="578 729 841 866"> <tbody> <tr> <td>UL (Unlock)</td> <td>Parameters change enabled.</td> </tr> <tr> <td>L (Lock)</td> <td>Parameters change disabled.</td> </tr> </tbody> </table> <p>Note: To lock and unlock parameters setting, follow the next steps: 1. In 'H95', press 'Ent' key once. The present status of parameters lock will appear (UL – Unlock, L – Lock). 2. Press 'Ent' key again and introduce the password registered in 'H94'. 3. Press 'Ent' key and immediately, the status of the parameters lock will be changed (UL → L, or L → UL). 4. Press 'Ent' key to return to 'H95'.</p>	UL (Unlock)	Parameters change enabled.	L (Lock)	Parameters change disabled.	YES
UL (Unlock)	Parameters change enabled.									
L (Lock)	Parameters change disabled.									

8.4. I/O group (I)

Parameter	Description	Range	Default value	Memory address	Function	Set during RUN
I0	Parameter jump	0 – 99	1	-	Parameter selection to jump.	YES
I2	Minimum voltage of NV input	0.00 – -10V	0.00V	A402	It sets the minimum voltage of the NV input (-10V – 0V).	YES
I3	Minimum freq. for NV input at min. voltage	0.00 – 400Hz	0.00Hz	A403	It sets the inverter output minimum frequency at minimum voltage of the NV input.	YES
I4	Maximum voltage of NV input	0.00 – -10V	10.00V	A404	It sets the maximum voltage of the NV input.	YES
I5	Maximum freq. for NV input at max. voltage	0.00 – 400Hz	50.00Hz	A405	It sets the inverter output maximum frequency at maximum voltage of the NV input.	YES
I6	Filter time constant for analog. voltage of V1 input	0 – 9999 ms	10ms	A406	It sets the responsiveness of V1 input (0 – +10V).	YES
I7	Minimum voltage of V1 input	0 – 10V	0V	A407	It sets the minimum voltage of the V1 input.	YES
I8	Minimum freq. for V1 input at min. voltage	0.00 – 400Hz	0.00	A408	It sets the inverter output minimum frequency at minimum voltage of the V1 input.	YES
I9	Maximum voltage of V1 input	0 – 10V	10V	A409	It sets the maximum voltage of the V1 input.	YES
I10	Maximum freq. for V1 input at max. voltage	0.00 – 400Hz	50.00Hz	A40A	It sets the inverter output maximum frequency at maximum voltage of the V1 input.	YES
I11	Filter time constant for analog. current of I input	0 – 9999 ms	10ms	A40B	It sets the input section's internal filter constant for I input.	YES

Parameter	Description	Range	Default value	Memory address	Function	Set during RUN						
I12	Minimum current of I input	0.00 – 20.00mA	4.00mA	A40C	It sets the minimum current of I input.	YES						
I13	Minimum freq. for I input at minimum current	0.00 – 400Hz	0.00Hz	A40D	It sets the inverter output minimum frequency at minimum current of I input.	YES						
I14	Maximum current of I input	0.00 – 20.00mA	20.00mA	A40E	It sets the maximum current of I input.	YES						
I15	Maximum freq. for I input at maximum current	0.00 – 400Hz	50.00Hz	A40F	It sets the inverter output maximum frequency at maximum current of I input.	YES						
I16	Criteria for signal loss of reference analogue input	0 – 2	0	A410	<table border="1"> <tr> <td>0</td> <td>Disabled.</td> </tr> <tr> <td>1</td> <td>Activated below half of minimum set value.</td> </tr> <tr> <td>2</td> <td>Activated below minimum set value.</td> </tr> </table> <p>When the time set in 'I63 → Time to determine speed reference signal loss' has elapsed, on which any reference signal is applied to the inverter, or a reference signal which value is below half of (if 'I16' is set to '1'), or only below (if 'I16' is set to '2') minimum set value (which can be a voltage or current value) is applied, the inverter will stop according to the setting of 'I62 → Stop mode when reference signal loss occurs'.</p>	0	Disabled.	1	Activated below half of minimum set value.	2	Activated below minimum set value.	YES
0	Disabled.											
1	Activated below half of minimum set value.											
2	Activated below minimum set value.											

Parameter	Description	Range	Default value	Memory address	Function	Set during RUN	
I17	Configuration of multi-function digital input P1	0 – 29	0	A411	Note: Each multi-function digital input should be configured with different option.	YES	
					0		Forward Run command (FX).
					1		Reverse Run command (RX).
					2		Emergency stop trip.
I18	Configuration of multi-function digital input P2		1	A412	3	Fault reset.	YES
					4	Jog operation command.	
					5	Low Speed (Multi-step freq.).	
					6	Middle Speed (Multi-step freq.).	
I19	Configuration of multi-function digital input P3		2	A413	7	High Speed (Multi-step freq.).	YES
					8	Low Accel/Decel (Multi-accel/decel).	
					9	Middle Accel/Decel (Multi-accel/decel).	
					10	High Accel/Decel (Multi-accel/decel).	
I20	Configuration of multi-function digital input P4		3	A414	11	DC brake.	YES
					12	Selection of second motor.	
					13	-Reserved-	
					14	-Reserved-	
I21	Configuration of multi-function digital input P5		4	A415	15	Up – Frequency increase. -- Motorized Pot. function --	YES
					16	Down – Frequency decrease.	
					17	3-wire operation.	
					18	External trip: A Contact (EtA).	
					19	External trip: B Contact (EtB).	YES
					20	Self-diagnostic function.	
					21	Exchange between PID operation and V/F operation.	
					22	2° setting: - Drive mode 2 - Frequency setting mode 2 See parameters 'drv2' and 'Frg2'.	
					Note: See following page.		

Parameter	Description	Range	Default value	Memory address	Function	Set during RUN																
I22	Configuration of multi-function digital input P6	0 – 29	5	A416	<p>Note: Coming from the previous page.</p> <table border="1"> <tr> <td>23</td> <td>Capture of reference frequency value (when 'Frq' is set from '2' to '7').</td> </tr> <tr> <td>24</td> <td>Accel/decel disabled.</td> </tr> </table>	23	Capture of reference frequency value (when 'Frq' is set from '2' to '7').	24	Accel/decel disabled.	YES												
23	Capture of reference frequency value (when 'Frq' is set from '2' to '7').																					
24	Accel/decel disabled.																					
I23	Configuration of multi-function digital input P7	6	A417	<table border="1"> <tr> <td>25</td> <td>Initialization. Up/Down Save frequency.</td> </tr> <tr> <td>26</td> <td>JOG – FX (Forward Jog Frequency).</td> </tr> <tr> <td>27</td> <td>JOG – RX (Reverse Jog Frequency).</td> </tr> </table>	25	Initialization. Up/Down Save frequency.	26	JOG – FX (Forward Jog Frequency).	27	JOG – RX (Reverse Jog Frequency).	YES											
25	Initialization. Up/Down Save frequency.																					
26	JOG – FX (Forward Jog Frequency).																					
27	JOG – RX (Reverse Jog Frequency).																					
I24	Configuration of multi-function digital input P8	7	A418	<table border="1"> <tr> <td>28</td> <td>Alternative reference source (see parameter 'Frq3').</td> </tr> <tr> <td>29</td> <td>Fire mode (see parameter 'I90').</td> </tr> </table>	28	Alternative reference source (see parameter 'Frq3').	29	Fire mode (see parameter 'I90').	YES													
28	Alternative reference source (see parameter 'Frq3').																					
29	Fire mode (see parameter 'I90').																					
I25	Input terminals status	-	0	A419	<table border="1"> <tr> <td>Bit 7</td><td>Bit 6</td><td>Bit 5</td><td>Bit 4</td><td>Bit 3</td><td>Bit 2</td><td>Bit 1</td><td>Bit 0</td> </tr> <tr> <td>P8</td><td>P7</td><td>P6</td><td>P5</td><td>P4</td><td>P3</td><td>P2</td><td>P1</td> </tr> </table>	Bit 7	Bit 6	Bit 5	Bit 4	Bit 3	Bit 2	Bit 1	Bit 0	P8	P7	P6	P5	P4	P3	P2	P1	YES
Bit 7	Bit 6	Bit 5	Bit 4	Bit 3	Bit 2	Bit 1	Bit 0															
P8	P7	P6	P5	P4	P3	P2	P1															
I26	Output terminals status	-	0	A41A	<table border="1"> <tr> <td>Bit 1</td><td>Bit 0</td> </tr> <tr> <td>3AC</td><td>MO</td> </tr> </table>	Bit 1	Bit 0	3AC	MO	YES												
Bit 1	Bit 0																					
3AC	MO																					
I27	Filter time constant for digital inputs	1 – 15	4	A41B	Filter for digital inputs, effective in case of inputs are affected by the noise. If this value is increased, the response time is getting slower.	YES																
I30	Multi-step frequency 4	0.00 – 400Hz	30.00Hz	A41E	Setting of the multi-step frequency values 4 – 7 which will be applied as multiple speeds in multi-step operation. It cannot be set greater than 'F21 → Maximum frequency'. Note: In PID mode, PID multi-references setting. They are set in Hz (Max. Freq. (Hz) = 100% PID Ref.).	YES																
I31	Multi-step frequency 5		25.00Hz	A41F		YES																
I32	Multi-step frequency 6		20.00Hz	A420		YES																
I33	Multi-step frequency 7		15.00Hz	A421		YES																

Parameter	Description	Range	Default value	Memory address	Function	Set during RUN
I34	Multi-accel. time 1	0.0 – 6000 sec	3.0 sec	A422	Setting of the time values which will be applied as multiple acceleration and deceleration ramps. Note: Regarding 'Double accel/decel ramp' function, the ramps set in parameters I34 and I35 will be applied when the frequency of the inverter is below the frequency value set in parameter H69.	YES
I35	Multi-decel. time 1		3.0 sec	A423		YES
I36	Multi-accel. time 2		4.0 sec	A424		YES
I37	Multi-decel. time 2		4.0 sec	A425		YES
I38	Multi-accel. time 3		5.0 sec	A426		YES
I39	Multi-decel. time 3		5.0 sec	A427		YES
I40	Multi-accel. time 4		6.0 sec	A428		YES
I41	Multi-decel. time 4		6.0 sec	A429		YES
I42	Multi-accel. time 5		7.0 sec	A42A		YES
I43	Multi-decel. time 5		7.0 sec	A42B		YES
I44	Multi-accel. time 6		8.0 sec	A42C		YES
I45	Multi-decel. time 6		8.0 sec	A42D		YES
I46	Multi-accel. time 7		9.0 sec	A42E		YES
I47	Multi-decel. time 7		9.0 sec	A42F		YES

Parameter	Description	Range	Default value	Memory address	Function	Set during RUN		
I50	Analogue output mode	0 – 3	0	A432	Option	Output to 10V 200V 400V	YES	
					0	Output frequency		Maximum freq.
					1	Output current		150 %
					2	Output voltage		AC 282V AC 564V
					3	Inverter DC Link voltage		DC 400V DC 800V
I51	Analogue output setting	10 – 200%	100%	A433	Based on 10V.	YES		
I52	Level of frequency detection	0.00 – 400Hz	30.00Hz	A434	These parameters are used when 'I54 → Multi-function output configuration' or 'I55 → Multi-function relay configuration' are set between 0-4. Cannot be set higher than 'F21 → Maximum frequency'.	YES		
I53	Bandwidth of frequency detection		10.00Hz	A435		YES		

Parameter	Description	Range	Default value	Memory address	Function	Set during RUN	
I54	Multi-function output (MO) configuration	0 – 19	12	A436	Multi-function output and/or multi-function relay will be activated when selected condition is given according to following table. If they are set to '17 → Fault output', the multi-function output and/or relay will be activated according to the setting of 'I56 → Fault relay configuration'.	YES	
					0		FDT-1; ON condition: (Ref.Freq. – Output Freq.) ≤ (I53/2)
					1		FDT-2; ON condition: (Ref.Freq. – Output Freq.) ≤ (I53/2), if Ref.Freq. = I52
					2		FDT-3; ON condition: (I52 – Output Freq.) ≤ (I53/2)
					3		FDT-4; ON condition: During Accel.: Output Freq. ≥ I52 During Decel.: Output Freq. > (I52 – (I53/2))
I55	Multi-function relay (3A, B, C) configuration	0 – 19	17	A437	FDT-5; ON condition: During Accel.: Output Freq. < I52 During Decel.: Output Freq. ≤ (I52 – (I53/2))	YES	
					4		FDT-5; ON condition: During Accel.: Output Freq. < I52 During Decel.: Output Freq. ≤ (I52 – (I53/2))
					5		Overload (OLt).
					6		Inverter overload (IOLt).
					7		Motor stall.
					8		Over voltage trip (Ovt).
					9		Low voltage trip (Lvt).
					10		Inverter overheating (Oht).
					11		Reference signal loss.
					12		During Run.
					13		During Stop.
					14		During steady status.
					15		During Speed search.
					16		Wait time for run signal input.
					17		Fault output.
18	Warning for cooling fan trip.						
19	Brake signal select.						

Parameter	Description	Range	Default value	Memory address	Function	Set during RUN																																								
156	Fault relay configuration	0 – 7	2	A438	<p>If '154 → Multi-function output configuration' and/or '155 → Multi-function relay configuration' are set to '17 → Fault output', the multi-function output and/or relay will be activated when a fault occurs according to the configuration of '156'.</p> <table border="1"> <thead> <tr> <th></th> <th>Tries of auto fault reset (H26)</th> <th>With any different fault of 'Low voltage'</th> <th>With 'Low voltage fault'</th> </tr> <tr> <th></th> <th>Bit 2</th> <th>Bit 1</th> <th>Bit 0</th> </tr> </thead> <tbody> <tr> <td>0</td> <td>-</td> <td>-</td> <td>-</td> </tr> <tr> <td>1</td> <td>-</td> <td>-</td> <td>✓</td> </tr> <tr> <td>2</td> <td>-</td> <td>✓</td> <td>-</td> </tr> <tr> <td>3</td> <td>-</td> <td>✓</td> <td>✓</td> </tr> <tr> <td>4</td> <td>✓</td> <td>-</td> <td>-</td> </tr> <tr> <td>5</td> <td>✓</td> <td>-</td> <td>✓</td> </tr> <tr> <td>6</td> <td>✓</td> <td>✓</td> <td>-</td> </tr> <tr> <td>7</td> <td>✓</td> <td>✓</td> <td>✓</td> </tr> </tbody> </table>		Tries of auto fault reset (H26)	With any different fault of 'Low voltage'	With 'Low voltage fault'		Bit 2	Bit 1	Bit 0	0	-	-	-	1	-	-	✓	2	-	✓	-	3	-	✓	✓	4	✓	-	-	5	✓	-	✓	6	✓	✓	-	7	✓	✓	✓	YES
	Tries of auto fault reset (H26)	With any different fault of 'Low voltage'	With 'Low voltage fault'																																											
	Bit 2	Bit 1	Bit 0																																											
0	-	-	-																																											
1	-	-	✓																																											
2	-	✓	-																																											
3	-	✓	✓																																											
4	✓	-	-																																											
5	✓	-	✓																																											
6	✓	✓	-																																											
7	✓	✓	✓																																											
157	Output configuration when communic. error occurs	0 – 3	0	A439	<p>When a communication error occurs 'Err', the multi-function output and/or relay can be activated.</p> <table border="1"> <thead> <tr> <th></th> <th>Multi-function relay</th> <th>Multi-function output</th> </tr> <tr> <th></th> <th>Bit 1</th> <th>Bit 0</th> </tr> </thead> <tbody> <tr> <td>0</td> <td>-</td> <td>-</td> </tr> <tr> <td>1</td> <td>-</td> <td>✓</td> </tr> <tr> <td>2</td> <td>✓</td> <td>-</td> </tr> <tr> <td>3</td> <td>✓</td> <td>✓</td> </tr> </tbody> </table>		Multi-function relay	Multi-function output		Bit 1	Bit 0	0	-	-	1	-	✓	2	✓	-	3	✓	✓	YES																						
	Multi-function relay	Multi-function output																																												
	Bit 1	Bit 0																																												
0	-	-																																												
1	-	✓																																												
2	✓	-																																												
3	✓	✓																																												
159	Selection of communic. protocol	0	0	A43B	Setting of communication protocol. <table border="1"> <tr> <td>0</td> <td>Modbus RTU</td> </tr> </table>	0	Modbus RTU	NO																																						
0	Modbus RTU																																													
160	Slave number in communic. net	1 – 250	1	A43C	Setting for RS485 communication.	YES																																								

Parameter	Description	Range	Default value	Memory address	Function	Set during RUN										
I61	Transmission speed in communic. net	0 – 4	3	A43D	Setting of transmission speed for RS485 communication. <table border="1" data-bbox="612 282 785 413"> <tr><td>0</td><td>1200 bps</td></tr> <tr><td>1</td><td>2400 bps</td></tr> <tr><td>2</td><td>4800 bps</td></tr> <tr><td>3</td><td>9600 bps</td></tr> <tr><td>4</td><td>19200 bps</td></tr> </table>	0	1200 bps	1	2400 bps	2	4800 bps	3	9600 bps	4	19200 bps	YES
0	1200 bps															
1	2400 bps															
2	4800 bps															
3	9600 bps															
4	19200 bps															
I62	Stop mode after reference signal loss	0 – 2	0	A43E	This parameter is used when the reference frequency is given by V1/I terminals or by RS485. The inverter operates according to this parameter setting after the time set in 'I63 → Time to determine speed reference signal loss' is elapsed. <table border="1" data-bbox="534 569 850 768"> <tr><td>0</td><td>Non stop: continuous operation at the previous frequency to the reference frequency loss.</td></tr> <tr><td>1</td><td>Free run: the inverter turns off the output and the motor is stopped by inertia.</td></tr> <tr><td>2</td><td>Decel. to stop: the inverter applies a deceleration ramp.</td></tr> </table> This parameter is enable when 'I16 → Criteria for reference analogue input signal loss' is set to '1 → Activated below half of minimum set value' or to '2 → Activated below minimum set value'.	0	Non stop: continuous operation at the previous frequency to the reference frequency loss.	1	Free run: the inverter turns off the output and the motor is stopped by inertia.	2	Decel. to stop: the inverter applies a deceleration ramp.	YES				
0	Non stop: continuous operation at the previous frequency to the reference frequency loss.															
1	Free run: the inverter turns off the output and the motor is stopped by inertia.															
2	Decel. to stop: the inverter applies a deceleration ramp.															
I63	Time to determine speed reference signal loss	0.1 – 120 sec	1.0 sec	A43F	Setting of the time that the inverter will wait it before considering that the reference signal has been lost. In that moment, The inverter operates according to the setting of 'I62 → Stop mode after reference signal loss'. This parameter is enable when 'I16 → Criteria for reference analogue input signal loss' is set to '1 → Activated below half of minimum set value' or to '2 → Activated below minimum set value'.	YES										

Parameter	Description	Range	Default value	Memory address	Function	Set during RUN		
I64	Communic. time setting	2 – 100ms	5ms	A440	Frame communication time.	YES		
I65	Parity/Stop bit setting	0 – 3	0	A441	When the protocol is set, the communication format can be set.	YES		
					0		Parity: None, Bit Stop: 1	
					1		Parity: None, Bit Stop: 2	
					2		Parity: Odd, Bit Stop: 1	
I66	Read address register 1	0 – A4FF	5	A442	The user can register up to 8 discontinuous addresses and read all of them with one read command.	YES		
			I67	Read address register 2		6	A443	YES
			I68	Read address register 3		7	A444	YES
			I69	Read address register 4		8	A445	YES
			I70	Read address register 5		9	A446	YES
			I71	Read address register 6		A	A447	YES
			I72	Read address register 7		B	A448	YES
			I73	Read address register 8		C	A449	YES

Parameter	Description	Range	Default value	Memory address	Function	Set during RUN
174	Write address register 1	0 – A4FF	5	A44A	The user can register up to 8 discontinuous addresses and write in all of them with one write command.	YES
175	Write address register 2		6	A44B		YES
176	Write address register 3		7	A44C		YES
177	Write address register 4		8	A44D		YES
178	Write address register 5		9	A44E		YES
179	Write address register 6		A	A44F		YES
180	Write address register 7		B	A450		YES
181	Write address register 8		C	A451		YES
182 ²³	Brake open current	0.0 – 180%	50.0%	A452	It allows setting the current level to open the brake. It is set in % of 'H33 → Motor rated current'.	YES
183 ²³	Brake open delay time	0.0 – 10s	1.0s	A453	It allows setting a delay time to open the brake.	NO
184 ²³	Brake open FX (Forward) frequency	0.00 – 400Hz	1.00Hz	A454	Forward frequency value to open the brake.	NO

²³ It is only displayed when parameter 'I54 → Multi-function output (MO) configuration' or 'I55 → Multi-function relay (3A, B, C) configuration' is configured with option '19 → Brake signal select'.









Parameter	Description	Range	Default value	Memory address	Function	Set during RUN				
185 ²⁴	Brake open RX (Reverse) frequency	0.00 – 400Hz	1.00Hz	A455	Reverse frequency value to open the brake.	NO				
186 ²⁴	Brake close delay time	0.0 – 10s	1.0s	A456	It allows setting a delay time to close the brake.	NO				
187 ²⁴	Brake close frequency	0.00 – 400Hz	2.00Hz	A457	It allows setting a frequency value to close the brake.	NO				
188	Fire mode frequency	0.00 – 400Hz	50.00Hz	A458	Reference frequency when the inverter operates in Fire mode. See parameter '196 → Fire mode'.	YES				
189	Minimum scaling factor for PID Feedback	0.0 – 100	0.0	A459	Minimum scaling factor for PID Feedback.	YES				
190	Maximum scaling factor for PID Feedback	0.0 – 100	100	A45A	Maximum scaling factor for PID Feedback.	YES				
191	Selection of contact type A (NO), or B (NC) for multi-function output (MO)	0 – 1	0	A45B	This parameter sets the contact type for MO multi-function digital input. <table border="1" style="margin-left: 20px;"> <tr> <td>0</td> <td>A Contact (Normally open).</td> </tr> <tr> <td>1</td> <td>B Contact (Normally close).</td> </tr> </table>	0	A Contact (Normally open).	1	B Contact (Normally close).	YES
0	A Contact (Normally open).									
1	B Contact (Normally close).									
192	On delay time for multi-function output (MO)	0.0 – 10 sec	0.0 sec	A45C	Delay time for connection of multi-function output (MO) contact.	NO				



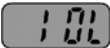





²⁴ It is only displayed when parameter '154 → Multi-function output (MO) configuration' or '155 → Multi-function relay (3A, B, C) configuration' is configured with option '19 → Brake signal select'.



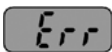
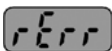

Parameter	Description	Range	Default value	Memory address	Function	Set during RUN				
I93	Off delay time for multi-function output (MO)	0.0 – 10 sec	0.0 sec	A45D	Delay time for disconnection multi-function output (MO) contact.	NO				
I94	On delay time for multi-function relay 3A, B, C	0.0 – 10 sec	0.0 sec	A45E	Delay time for connection of 3A, B, C multi-function relay contact.	NO				
I95	Off delay time for multi-function relay 3A, B, C	0.0 – 10 sec	0.0 sec	A45F	Delay time for disconnection of 3A, B, C multi-function relay contact.	NO				
I96	Fire mode	0 – 1	-	A460	<p>It allows displaying if Fire mode has been activated. This value is not initialized. If this value changes to '1', the warranty of the equipment is not valid any more.</p> <p>This operation mode is used as an emergency start. The inverter ignores all of faults and tries to start automatically. To activate Fire mode you should configure one of the multi-function digital inputs (I17-I24) as '29 → Fire mode' and then activate it. In this operation mode, control mode is changed to V/F and acceleration and deceleration times change to 10s. Moreover, frequency reference is introduced by 'I88 → Fire mode frequency'.</p> <p>To come back to the previous status (before Fire mode activation) you must turn off the inverter power and then turn on again.</p> <p>Caution: the inverter may get damaged.</p> <table border="1"> <tbody> <tr> <td>0</td> <td>No. Fire mode has not been activated.</td> </tr> <tr> <td>1</td> <td>Yes. Fire mode has been activated.</td> </tr> </tbody> </table>	0	No. Fire mode has not been activated.	1	Yes. Fire mode has been activated.	-
0	No. Fire mode has not been activated.									
1	Yes. Fire mode has been activated.									

9. FAULT MESSAGES

9.1. Displayed faults



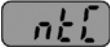



Display	Protection function	Description
	Overcurrent	The inverter turns off its output when its output current is above 200% of the inverter rated current.
	Overcurrent 2	When IGBT's Arm is short and output short occurs, the inverter turns off its output.
	Ground fault current	The inverter turns off its output when a ground faults occurs and the ground fault current is more than the internal setting value of the inverter. Over current protection function protects the inverter from any ground fault caused by a small earth leakage resistor.
	Inverter overload	The inverter turns off its output when its output current is greater than the rated level (150% for 1 minute).
	Overload trip	The inverter turns off its output when its output current is at 150% of the inverter rated current for more than the current limit time (1 minute).
	Inverter overheat	The inverter turns off its output when is overheated due to a damaged cooling fan or an alien substance present in the cooling system.
	Output phase loss	The inverter turns off its output when one or more of the output phase (U, V, W) is disconnected (open). The inverter detects the output current to check the phase loss of the output.
	Over voltage	The inverter turns off its output if the DC voltage of the main circuit exceeds the internal configured value (400V) when the motor accelerates or the regenerative motor energy, returned through the inverter, is too high for the DC Link capacitors. This fault can also occur due to a surge voltage generated at the power supply system.
	Low voltage	The inverter turns off its output if the DC voltage is below the detection level (180V) because insufficient torque or overheating of the motor can occur when the input voltage of the inverter drops.











Display	Protection function	Description
	Electronic thermal protection	The electronic thermal protection of the inverter determines the overheating of the motor. If the motor is overloaded the inverter turns off the output. The inverter cannot protect the motor when driving a motor having more than 4 poles or multiples motors. For this reason, is recommended to install a thermal protection for each motor.
	Input phase loss	The inverter turns off its output when one of the R, S, T phases is disconnected (open) or when the electrolytic capacitor needs to be replaced.
	Self-diagnostic malfunction	Displayed when IGBT damaged, output phase short, output phase ground fault or output phase open occurs.
	Parameter save error	Displayed when user-setting parameters fails to be entered into memory.
	Inverter hardware fault	A fault signal is generated when an error occurs in the control circuitry of the inverter.
	Communication error	Displayed when the inverter cannot communicate with the keypad/display unit.
	Remote keypad communication error	This fault is displayed when the inverter and remote keypad do not communicate each other. It does not stop inverter operation.
	Keypad error	Displayed after inverter resets keypad when keypad error occurs and this status is hold for a certain time.
	Cooling fan fault	This fault is displayed when a fault condition occurs in the inverter cooling fan.
	Emergency stop (instant cut off)	Used for the emergency stop of the inverter. The inverter instantly turns off the output when BX terminal is ON. Caution: The inverter starts to regular operation when turning off BX terminal while Fx or RX terminal is ON.

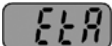



Display	Protection function	Description
	External fault A contact (NO) input	The inverter turns off the output if some of the multi-function digital inputs (I17 – I24) set to '18 → External trip: A Contact (EtA)' is activated.
	External fault B contact (NC) input	The inverter turns off the output if some of the multi-function digital inputs (I17 – I24) set to '19 → External trip: B Contact (EtB)' is activated.
	Operation method when the reference frequency is lost	When inverter operation is set using analogue input (0 – 10V or 0 – 20mA) or using communication net (RS485 option) and reference signal is lost, operation mode is done according to the method set in 'I62 → Stop mode after reference signal loss'.
	NTC open	NTC is disconnected. Outputs are disabled.
	Brake control error	When Brake control, if rating current flows below than the set value, cut off the output without brake open.

9.2. Displayed faults remedy

Display / Function	Cause	Remedy
 Overcurrent	Acceleration / deceleration time is too short compared to the load inertia (GD^2).	Increase the acceleration / deceleration time.
	Load is greater than the inverter rated power.	Increase the inverter rated power.
	Inverter tries to start when the motor is free running.	Check the correct programming of the start conditions when the motor is running. Set an appropriate inertia load value and set parameters which active speed search correctly. Note: Safety conditions which allow to appropriate start when motor is running depend on each installation.
	Output short circuit or ground fault has occurred.	Check output wiring.
	Mechanical brake of the motor is operating too fast.	Check the mechanical brake operation.
	Components of power circuit have been overheated due to the cooling fan malfunction.	Check the cooling fan. Verify the cooling fan is power supplied correctly and there is not any alien substance into it.
	Caution: When an over current fault occurs, operation must be started after the cause is removed to avoid damage to IGBT inside the inverter.	
 Overcurrent 2	Short occurs between up and down of IGBT.	Check the IGBT.
	Inverter output short occurs.	Check output wiring.
	Acceleration / deceleration time is too short compared to the load inertia (GD^2).	Increase the acceleration / deceleration time.
 Ground fault current	Ground fault current has occurred at the output wiring of the inverter.	Check the wiring of the inverter output.
	The insulation of the motor is damaged due to heat.	Replace the motor.

Display / Function	Cause	Remedy
 Inverter overload	Load is greater than the inverter rated power.	Increase the rated power of the motor and the inverter.
 Overload trip	Torque boost scale is set too large.	Reduce torque boost scale.
 Inverter overheat	Cooling fan damaged or an alien substance is into the cooling system.	Replace the cooling fans and/or eliminate the alien substances.
	Cooling system has fault.	Check for alien substances clogged in the cooling system.
	Ambient temperature is too high.	Keep ambient temperature under 50°C or verify the capacity of the inverter according to this capacity.
 Output phase loss	Faulty contact of magnetic switch at output.	Check the magnetic switch of the output.
	Faulty output wiring.	Check the output wiring.
 Over voltage	Deceleration time is too short compared to the load inertia (GD^2).	Increase deceleration time.
	Regenerative load is at the inverter output.	Use an optional dynamic brake resistor.
	Line voltage is too high.	Check line voltage.
 Low voltage	Line voltage is low.	Check line voltage.
	Load larger than line capacity is connected to line (welding machine, motor with high starting current connected to the commercial line).	Increase the line rated power.
	Faulty magnetic switch at the input side of the inverter.	Replace the magnetic switch.

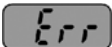
Display / Function	Cause	Remedy							
 Electronic thermal protection	Motor has been overheated.	Reduce load weight and/or operation duty.							
	Load is greater than inverted rated capacity.	Use an inverter with higher capacity.							
	Electronic thermal protection level (ETH) is set too low.	Set ETH level to an appropriate value.							
	Inverter rated power is incorrectly selected.	Select correct inverter rated power.							
	Inverter has been operated at low speed for too long.	Install a cooling fan with an external power supply to motor.							
 Cooling fan fault	An alien substance is clogged in a ventilating slot.	Check the ventilating slot and remove the clogged substances.							
	The inverter has been in use without changing the damaged cooling fan.	Replace the cooling fan.							
 External fault A contact input	The terminal set to '18 → External trip: A Contact' and/or the terminal set to '19 → External trip: B Contact' are ON.	Eliminate the cause of fault at circuit connected to defined terminal as external fault A and/or B contact input.							
 External fault B contact input			 Operating method when the reference frequency is lost	No reference frequency is applied to V1 and/or I inputs.	Check the wiring of V1 and/or I inputs. Check the reference frequency level.	 Remote keypad communication error	Communication error between inverter keypad unit and remote keypad.	Check for connection of communication line and connector.	 Brake control error
 Operating method when the reference frequency is lost	No reference frequency is applied to V1 and/or I inputs.	Check the wiring of V1 and/or I inputs. Check the reference frequency level.							
 Remote keypad communication error	Communication error between inverter keypad unit and remote keypad.	Check for connection of communication line and connector.							
 Brake control error	Break open current is not flow any more.	Check the motor capacity and wiring.							

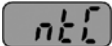
Display / Function	Cause	Remedy
 Parameter save error		
 Inverter hardware fault	'EEP': Parameter save error.	
	'HWT': Inverter hardware fault.	
 Communication error	'Err': Communication error.	Get in contact with an official distributor of POWER ELECTRONICS.
	'COM': Keypad error.	
 Keypad error	'NTC': NTC error.	
 NTC error		

9.3. Maintenance

9.3.1. Warnings

- Be sure to remove the input power while performing maintenance.
- Be sure to perform maintenance after checking the DC Link capacitor has discharged. Check that the voltage between terminals P – N, or P1 – N is below DC 30V. The bus capacitors in the inverter main circuit can still be charged even after the power is turned off.
- The correct output voltage of the inverter can only be measured by using a rectifier voltage meter. Others voltage meters, including digital voltage meters, are likely to display incorrect values caused by the high frequency PWM output voltage of the inverter.

9.3.2. Routine inspection

- Make sure there are proper conditions in the location of the installation.
- Make sure there are proper conditions to inverter cooling system.
- Check unusual vibration and noise.
- Check unusual overheating.

9.3.3. Periodic inspection

- Check if there are screws and bolts loose. In this case, tighten them or replace them.
- Check if there is corrosion presence due to ambient conditions. In this case, replace the affected parts.
- Check the rotation condition of the cooling fan, the condition of capacitors and the connections with the magnetic contactor. Replace them if there are any abnormalities.

9.3.4. Part replacement

Inverters of SD250 Series consist of many electronic parts such as semiconductor devices. The following parts may deteriorate with age because of their structures or physical characteristics, leading to reduced performance or failure of the inverter. For preventive maintenance, the parts must be changed periodically. The parts replacement guidelines are indicated in the following table. LED's and other short-life parts must also be changed during periodic inspection.

Part	Periodic change	Description
Cooling fan	3 years	Replacement (as required)
DC Link capacitor in main circuit	4 years	Replacement (as required)
Electrolytic capacitor on control board	4 years	Replacement (as required)
Relays	-	Replacement (as required)

10. RS485 COMMUNICATION

10.1. Introduction

Inverter can be controlled and monitored by the sequence program of a PLC or other master module.

Drives or other slave devices can be connected in a RS485 network to be controlled by a PLC or computer. In this way, parameters setting and monitoring can be executed from a computer, using a user program.

To communicate, user can use any kind of RS232/485 converter, which specifications depend on the manufacturer.

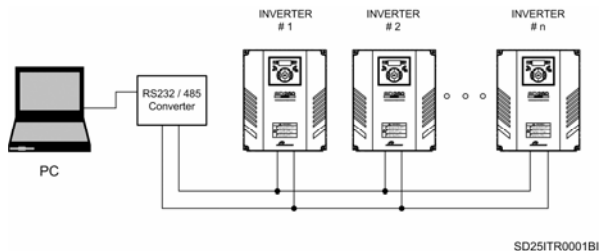

Figure 10.1 System configuration in RS485 network

10.2. Specifications

General specifications.

- Communication method: RS485.
- Transmission form: Bus method, Multi drop Link System.
- Applicable drive: SD250.
- Converter: RS232 converter.
- Connectable drives: Maximum 31.
- Transmission distance: Below 1.200m maximum (within 700m recommended).

Specifications of the installation.

- Cable recommended: 0.75mm² (18AWG), Shield type twisted-pair.
- Installation: S+ and S- terminals of TB1 connector located on control board.
- Power supply: Insulated power supply from the inverter power supply.

Specifications of the communication.

- Communication speed: 19200 / 9600 / 4800 / 2400 / 1200 bps. Selectable.
- Control procedure: Asynchronous communication system.
- Communication system: Half duplex system.
- Character system: ASCII (8 bit).
- Stop bit length: 2 bit (Modbus-RTU).
- Sum check: 2 byte.
- Parity check: None.

10.3. Installation

10.3.1. Connection of the communication cable

Use S+ terminal to connect RS485 high signal and use S- to connect RS485 low signal.

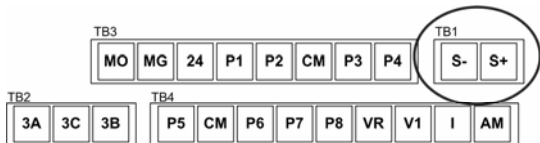

SD25DTC0005AE

Figure 10.2 TB1 connector of the control board

Note: Connect the screen of the communication cable to any CM terminal of the SD250, if the installation requires it.

After connecting the cable, set the following parameters as follows:

Param.	Description	Setting	
drv	Drive mode	3	RS485 communication.
Frq	Frequency setting mode	7	RS485 communication.
I60	Slave No. in communication net	1 – 250	Use different numbers in case of more than 1 inverter are installed.
I61	Transmission speed in communication net	3	3: 9.600bps (factory setting).
I62	Stop mode after reference signal loss	0	Non stop (factory setting).
I63	Time to determine speed reference signal loss	1.0sec	(Factory setting).
I59	Selection of communication protocol	0	0: Modbus RTU

10.3.2. Operation of the inverter in the communication network

After installing the equipment in the communication net, follow the steps below to operate with the inverter integrated in the network:

- Check if the computer and the inverter are connected correctly.
- Turn on the inverter, but do not connect the load until stable communication between the computer and the inverter is verified.
- Start the operating program for the inverter from the computer.
- Verify that the inverter operates in a correct way using the operating program from the computer.
- See '10.6 Faults solution' if the communication is not operating correctly.

10.4. Communication protocol MODBUS-RTU

Computer or other devices can be 'master' and inverters will be 'slave'. In this way, inverter responds to Read / Write command from master.

Supported function code.

Function code	Description
0x03	Read Hold Register
0x04	Read Input Register
0x06	Preset Single Register
0x10	Preset Multiple Register

Exception code.

Function code		Description
0x01		ILLEGAL FUNCTION When master is sending a code different to a read / write command (see supported function codes).
0x02		ILLEGAL DATA ADDRESS When parameter address does not exist.
0x03		ILLEGAL DATA VALUE When data is a value out of range for an inverter parameter during the writing.
0x06		SLAVE DEVICE BUSY
Defined by user	0x14	<ol style="list-style-type: none"> 1. Write disabled (address 0x0004 value is 0). 2. Read only or not program during run.

10.5. Address list

10.5.1. Common Area

Address	Parameter	Scale	Unit	R/W	Data value
0x0000	Inverter model			R	A: SD250
0x0001	Inverter capacity			R	FFFF: 0.4kW 0000: 0.75kW 0002: 1.5kW 0003: 2.2kW 0004: 3.7kW 0005: 4.0kW 0006: 5.5kW 0007: 7.5kW 0008: 11kW 0009: 15kW 000A: 18.5kW 000B: 22kW
0x0002	Inverter input voltage			R	0: 220Vac 1: 440Vac
0x0003	S/W version			R	(Ex) 0x010: Version 1.0 (Ex) 0x011: Version 1.1
0x0004	Parameter Lock			R/W	0: Lock (default) 1: Unlock
0x0005	Reference frequency	0.01	Hz	R/W	Start. freq. to Max. freq.

Address	Parameter	Scale	Unit	R/W	Data value	
0x0006	Run command			R/W	Bit 0: Stop	
					Bit 1: Forward run	
					Bit 2: Reverse run	
				W	Bit 3: Fault reset	
					Bit 4: Emergency stop	
				-	Bit 5: Not used	
				R	Bit 6 – 7: Reference introduction 0: Terminals 1: Keypad 2: Reserve 3: Communication	
					Bit 8 – 12: Reference frequency 0: DRV-00 1: Not used 2: Step frequency 1 3: Step frequency 2 4: Step frequency 3 5: Step frequency 4 6: Step frequency 5 7: Step frequency 6 8: Step frequency 7 9: Up speed 10: Down speed 11: Up/down zero 12: Analogue V0 13: Analogue V1 14: Analogue I 15: V0 + I 16: V1 + I 17: Jog frequency 18: PID 19: Communication 20 to 31: Reserve	
					Bit 15: Not used	
					0x0007	Acceleration time
0x0008	Deceleration time	0.1	sec		R/W	
0x0009	Output current	0.1	A		R	
0x000A	Output frequency	0.01	Hz		R	
0x000B	Output voltage	0.1	V		R	
0x000C	DC Link voltage	0.1	V		R	
0x000D	Output power	0.1	kW		R	

Address	Parameter	Scale	Unit	R/W	Data value
0x000E	Inverter status			R	Bit 0: Stop
					Bit 1: Forward run
					Bit 2: Reverse run
					Bit 3: Fault
					Bit 4: Accelerating
					Bit 5: Decelerating
					Bit 6: Steady status
					Bit 7: DC braking
					Bit 8: Stopping
					Bit 9: Not used
					Bit 10: Brake open
					Bit 11: Forward run command
					Bit 12: Reverse run command
					Bit 13: REM R/S
Bit 14: REM Freq.					
0x000F	Fault information			R	Bit 0: OCT
					Bit 1: OVT
					Bit 2: EXT-A
					Bit 3: EST (BX)
					Bit 4: COL
					Bit 5: GFT
					Bit 6: OHT
					Bit 7: ETH
					Bit 8: OLT
					Bit 9: HW-Diag
					Bit 10: EXT-B
					Bit 11: EEP
					Bit 12: FAN
					Bit 13: PO
					Bit 14: IOLT
Bit 15: LVT					
0x0010	Input terminal status			R	Bit 0: P1
					Bit 1: P2
					Bit 2: P3
					Bit 3: P4
					Bit 4: P5
					Bit 5: P6
					Bit 6: P7
					Bit 7: P8

Address	Parameter	Scale	Unit	R/W	Data value
0x0011	Output terminal status			R	Bit 0: Not used
					Bit 1: Not used
					Bit 2: Not used
					Bit 3: Not used
					Bit 4: MO
					Bit 5: Not used
					Bit 6: Not used
Bit 7: 3ABC					
0x0012	V1	0 – 3FF		R	Value corresponding to 0V – +10V
0x0013	V2	0 – 3FF		R	Value corresponding to 0V – -10V when setting freq mode to 2
0x0014	I	0 – 3FF		R	Value corresponding to 0 – 20mA
0x0015	RPM			R	Output speed
0x001A	Display unit			R	Not used
0x001B	Pole number			R	Not used
0x001C	Custom version			R	Not used
0x001D	Fault information-B			R	Bit 0: COM (I/O Board Reset).
					Bit 1: FLTL
					Bit 2: NTC
					Bit 3: REEP
					Bit 4: OC2
					Bit 5: NBR
Bit 6 – 15: Not used					
0x001E	PID Feedback		% or Engin. units	W	IT writes the feedback value in PID mode when the selected source is 'RS485 communication'.
0x0100 – 0x0107	Read address register			R	0x0100: 166 0x0101: 167 0x0102: 168 0x0103: 169 0x0104: 170 0x0105: 171 0x0106: 172 0x0107: 173
0x0108 – 0x010F	Write address register			W	0x0108: 174 0x0109: 175 0x010A: 176 0x010B: 177 0x010C: 178 0x010D: 179 0x010E: 180 0x010F: 181

Notes:

1. Run / Stop command by communication (address 0x0006)

All of the bits are activated when changing their status from 0 to 1. For example, if the drive trips due to a fault during running, the drive cannot start after resetting the fault until the start command is given again.

2. Addresses 0x0005 and 0x0006

The values of the addresses above indicated will be erased after the drive is power off. These addresses only keep their values while the drive is power on.

10.5.2. Drive group (DRV)

Address		Param.	Description	Default value	Range	
16 bit	10 bit				Max.	Min.
A100	41216	D0 (0.00)	Reference frequency	0	Max. Freq.	0
A101	41217	D1 (ACC)	Acceleration time	50	60000	0
A102	41218	D2 (dEC)	Deceleration time	100	60000	0
A103	41219	D3 (drv)	Drive mode	1	3	0
A104	41220	D4 (Frq)	Frequency setting mode	0	8	0
A105	41221	D5 (st1)	Multi-step frequency 1	1000	Max. Freq.	0
A106	41222	D6 (st2)	Multi-step frequency 2	2000	Max. Freq.	0
A107	41223	D7 (st3)	Multi-step frequency 3	3000	Max. Freq.	0
A108	41224	D8 (CUr)	Output current	0	1	0
A109	41225	D9 (rPM)	Motor RPM	0	1800	0
A10A	41226	D10 (dCL)	Inverter DC Link voltage	0	65535	0
A10B	41227	D11 (vOL)	User display selection	0	1	0
A10C	41228	D12 (nOn)	Fault display	0	1	0
A10D	41229	D13 (drC)	Selection of motor rotation direction	0	1	0
A10E	41230	D14 (drv2)	Drive mode 2	1	3	0
A10F	41231	D15 (Frq2)	Frequency setting mode 2	0	7	0
A110	41232	D16 (Frq3)	Frequency setting mode 3	0	7	0
A111	41233	D17 (rEF)	PID reference	0	1000	0
A112	41234	D18 (Fbk)	PID feedback	0	1000	0

10.5.3. Function 1 group (F)

Address		Param.	Description	Default value	Range	
16 bit	10 bit				Max.	Min.
A201	41473	F1	Prevention of motor rotation direction	0	2	0
A202	41474	F2	Acceleration pattern	0	1	0
A203	41475	F3	Deceleration pattern	0	1	0
A204	41476	F4	Stop mode	0	3	0
A208	41480	F8	DC brake start frequency	500	6000	Start. Freq.
A209	41481	F9	DC current application delay time	10	6000	0
A20A	41482	F10	DC current level for DC brake	50	200	0
A20B	41483	F11	DC current application time	10	600	0
A20C	41484	F12	DC current level before starting	50	200	0
A20D	41485	F13	DC current application time before starting	0	600	0
A20E	41486	F14	Time for magnetizing a motor	10	600	0
A214	41492	F20	Jog frequency	1000	Max. Freq.	0
A215	41493	F21	Maximum frequency	500	Max. Freq.	4000
A216	41494	F22	Base frequency	6000	Max. Freq.	3000
A217	41495	F23	Start frequency	50	1000	0
A218	41496	F24	Frequency limits selection	0	1	0
A219	41497	F25	High frequency limit	6000	Max. Freq.	0
A21A	41498	F26	Low frequency limit	50	High limit	Start freq.
A21B	41499	F27	Torque boost selection	0	1	0
A21C	41500	F28	Torque boost in forward direction	20	150	0
A21D	41501	F29	Torque boost in reverse direction	20	150	0
A21E	41502	F30	V/F Pattern	0	2	0

Address		Param.	Description	Default value	Range	
16 bit	10 bit				Max.	Min.
A21F	41503	F31	User V/F frequency 1	1250	Max. Freq.	0
A220	41504	F32	User V/F voltage 1	25	100	0
A221	41505	F33	User V/F frequency 2	2500	Max. Freq.	0
A222	41506	F34	User V/F voltage 2	500	100	0
A223	41507	F35	User V/F frequency 3	3750	Max. Freq.	0
A224	41508	F36	User V/F voltage 3	75	100	0
A225	41509	F37	User V/F frequency 4	5000	Max. Freq.	0
A226	41510	F38	User V/F voltage 4	100	100	0
A227	41511	F39	Output voltage setting	1000	1100	400
A228	41512	F40	Energy saving level	0	30	0
A232	41522	F50	Electronic thermal protection	1	1	0
A233	41523	F51	Level of Electronic thermal protection for 1 minute	150	200	F52
A234	41524	F52	Level of Electronic thermal protection for continuous	100	F51	50
A235	41525	F53	Motor cooling mode	0	1	0
A236	41526	F54	Overload warning level	150	150	30
A237	41527	F55	Overload warning time	100	300	0
A238	41528	F56	Overload trip selection	1	1	0
A239	41529	F57	Overload trip level	180	200	30
A23A	41530	F58	Overload trip time	600	600	0
A23B	41531	F59	Stall prevention mode	0	7	0
A23C	41532	F60	Stall prevention level	150	200	30

Address		Param.	Description	Default value	Range	
16 bit	10 bit				Max.	Min.
A23D	41533	F61	Voltage limit select when stall prevention mode during decel.	0	1	0
A23F	41535	F63	Save Up/Down frequency select	0	1	0
A240	41536	F64	Saved frequency in Up/Down mode	0	Max. Freq.	0
A241	41537	F65	Up/Down mode selection	0	2	0
A242	41538	F66	Step frequency in Up/Down mode	0	Max. Freq.	0
A246	41542	F70	Draw run mode selection	0	3	0
A247	41543	F71	Output frequency variation rate in Draw mode	0	1000	0

10.5.4. Function 2 group (H)

Address		Param.	Description	Default value	Range	
16 bit	10 bit				Max.	Min.
A300	41728	H0	Parameter jump	1	100	0
A301	41729	H1	Fault history 1	0	1	0
A302	41730	H2	Fault history 2	0	1	0
A303	41731	H3	Fault history 3	0	1	0
A304	41732	H4	Fault history 4	0	1	0
A305	41733	H5	Fault history 5	0	1	0
A306	41734	H6	Reset fault history	0	1	0
A307	41735	H7	Dwell frequency	500	Max. Freq.	Start freq.
A308	41736	H8	Dwell time	0	100	0
A30A	41738	H10	Selection of resonant frequencies	0	1	0
A30B	41739	H11	Low resonant frequency range 1	1000	H12	Start freq.
A30C	41740	H12	High resonant frequency range 1	1500	Max. Freq.	H11
A30D	41741	H13	Low resonant frequency range 2	2000	H14	Start freq.
A30E	41742	H14	High resonant frequency range 2	2500	Max. Freq.	H13
A30F	41743	H15	Low resonant frequency range 3	3000	H16	Start freq.
A310	41744	H16	High resonant frequency range 3	3500	Max. Freq.	H15
A311	41745	H17	S-Curve start	40	100	1
A312	41746	H18	S-Curve end	40	100	1
A313	41747	H19	Selection of input/output phase loss protection	0	3	0
A314	41748	H20	Restart after power supply fault	0	1	0
A315	41749	H21	Restart after fault reset	0	1	0
A316	41750	H22	Speed search function	0	15	0
A317	41751	H23	Current level for speed search	100	200	80
A318	41752	H24	P gain for Speed search	100	9999	0
A319	41753	H25	I gain for Speed search	1000	9999	0

Address		Param.	Description	Default value	Range	
16 bit	10 bit				Max.	Min.
A31A	41754	H26	Tries of automatic fault resets (Auto-restart)	0	10	0
A31B	41755	H27	Time between tries of automatic fault resets	10	600	0
A31E	41758	H30	Motor power setting	7	7	0
A31F	41759	H31	Selection of number of motor poles	4	12	2
A320	41760	H32	Rated slip frequency	233	1000	0
A321	41761	H33	Motor rated current	263	500	10
A322	41762	H34	No load motor current	110	200	1
A324	41764	H36	Motor efficiency	87	100	50
A325	41765	H37	Load inertia rate	0	2	0
A327	41767	H39	Setting of carrier frequency	30	150	10
A328	41768	H40	Selection of control mode	0	3	0
A329	41769	H41	Auto-tuning of motor parameters	0	1	0
A32A	41770	H42	Stator resistance (Rs)	2500	14000	0
A32C	41772	H44	Leakage inductance	2600	30000	0
A32D	41773	H45	Sensorless P gain	1000	32767	0
A32E	41774	H46	Sensorless I gain	10	32767	0
A32F	41775	H47	Sensorless torque limit	1800	2200	1000
A330	41776	H48	PWM mode selection	0	1	0
A331	41777	H49	PID control selection	0	1	0
A332	41778	H50	PID feedback setting	0	2	0
A333	41779	H51	P gain for PID mode	3000	9999	0
A334	41780	H52	I gain for PID mode	10	3200	100
A335	41781	H53	D gain for PID mode	0	3000	0
A336	41782	H54	PID control mode selection	0	1	0

Address		Param.	Description	Default value	Range	
16 bit	10 bit				Max.	Min.
A337	41783	H55	High limit of output frequency in PID mode	6000	Max. Freq.	Start freq.
A338	41784	H56	Low limit of output frequency in PID mode	50	Max. Freq.	0
A339	41785	H57	PID reference mode setting	0	4	0
A33B	41787	H59	Output inversion in PID mode	0	1	0
A33C	41788	H60	Selection of self-diagnostic	0	3	0
A33D	41789	H61	Sleep delay time	600	20000	0
A33E	41790	H62	Sleep frequency	0	Max. Freq.	0
A33F	41791	H63	Wake up level in Sleep mode	20	500	0
A340	41792	H64	KEB operation selection	0	1	0
A341	41793	H65	KEB operation start level	1250	1400	1100
A342	41794	H66	KEB operation stop level	1300	1450	1100
A343	41795	H67	KEB operation gain	1000	20000	1
A345	41797	H69	Frequency of accel/decel change	0	Max. Freq.	0
A346	41798	H70	Reference frequency for accel/decel	0	1	0
A347	41799	H71	Accel/Decel time scale	1	2	0
A348	41800	H72	Power on display	0	17	0
A349	41801	H73	Selection of user screen	0	2	0
A34A	41802	H74	Displaying of gain for motor rpm	100	1000	1
A34B	41803	H75	Selection of operation rate limit of dynamic brake resistor	1	1	0
A34C	41804	H76	Operation rate of dynamic brake resistor	10	30	0

Address		Param.	Description	Default value	Range	
16 bit	10 bit				Max.	Min.
A34D	41805	H77	Cooling fan control	0	1	0
A34E	41806	H78	Selection of operation mode when cooling fan malfunctions	0	1	0
A34F	41807	H79	Software version	2X	100	0
A351	41809	H81	Accel. time for second motor	50	60000	0
A352	41810	H82	Decel. time for second motor	100	60000	0
A353	41811	H83	Base frequency for second motor	5000	Max. Freq.	3000
A354	41812	H84	V/F Pattern for second motor	0	2	0
A355	41813	H85	Forward torque boost for second motor	50	150	0
A356	41814	H86	Reverse torque boost for second motor	50	150	0
A357	41815	H87	Stall prevention level for second motor	150	150	30
A358	41816	H88	Electronic thermal protection for 1 minute for second motor	150	200	H89
A359	41817	H89	Electronic thermal protect. for continuous for second motor	100	H88	50
A35A	41818	H90	Motor rated current for second motor	263	500	10
A35B	41819	H91	Parameters read	0	1	0
A35C	41820	H92	Parameters write	0	1	0
A35D	41821	H93	Parameters initialize	0	5	0
A35E	41822	H94	Password register	0	65535	0
A35F	41823	H95	Parameters lock	0	65535	0

10.5.5. I/O group (I)

Address		Param.	Description	Default value	Range	
16 bit	10 bit				Max.	Min.
A402	41986	I2	Minimum voltage of NV input	0	1000	0
A403	41987	I3	Minimum freq. for NV input at min. voltage	0	Max. Freq.	0
A404	41988	I4	Maximum voltage of NV input	1000	1000	0
A405	41989	I5	Maximum freq. for NV input at max. voltage	6000	Max. Freq.	0
A406	41990	I6	Filter time constant for analog. voltage of V1 input	10	9999	0
A407	41991	I7	Minimum voltage of V1 input	0	1000	0
A408	41992	I8	Minimum freq. for V1 input at min. voltage	0	Max. Freq.	0
A409	41993	I9	Maximum voltage for V1 input	1000	1000	0
A40A	41994	I10	Maximum freq. for V1 input at max. voltage	6000	Max. Freq.	0
A40B	41995	I11	Filter time constant for analog. current of I input	10	9999	0
A40C	41996	I12	Minimum current of I input	400	2000	0
A40D	41997	I13	Minimum freq. for I input at minimum current	0	Max. Freq.	0
A40E	41998	I14	Maximum current of I input	2000	2000	0
A40F	41999	I15	Maximum freq. for I input at max. current	6000	Max. Freq.	0
A410	42000	I16	Criteria for signal loss of reference analogue input	0	2	0
A411	42001	I17	Configuration of multi-function digital input P1	0	29	0
A412	42002	I18	Configuration of multi-function digital input P2	1	29	0
A413	42003	I19	Configuration of multi-function digital input P3	2	29	0
A414	42004	I20	Configuration of multi-function digital input P4	3	29	0
A415	42005	I21	Configuration of multi-function digital input P5	4	29	0

Address		Param.	Description	Default value	Range	
16 bit	10 bit				Max.	Min.
A416	42006	I22	Configuration of multi-function digital input P6	5	29	0
A417	42007	I23	Configuration of multi-function digital input P7	6	29	0
A418	42008	I24	Configuration of multi-function digital input P8	7	29	0
A419	42009	I25	Input terminals status	0	255	0
A41A	42010	I26	Output terminals status	0	3	0
A41B	42011	I27	Filter time constant for digital inputs	15	50	2
A41E	42014	I30	Multi-step frequency 4	3000	Max. Freq.	0
A41F	42015	I31	Multi-step frequency 5	2500	Max. Freq.	0
A420	42016	I32	Multi-step frequency 6	2000	Max. Freq.	0
A421	42017	I33	Multi-step frequency 7	1500	Max. Freq.	0
A422	42018	I34	Multi-accel time 1	30	60000	0
A423	42019	I35	Multi-decel time 1	30	60000	0
A424	42020	I36	Multi-accel time 2	40	60000	0
A425	42021	I37	Multi-decel time 2	40	60000	0
A426	42022	I38	Multi-accel time 3	50	60000	0
A427	42023	I39	Multi-decel time 3	50	60000	0
A428	42024	I40	Multi-accel time 4	60	60000	0
A429	42025	I41	Multi-decel time 4	60	60000	0
A42A	42026	I42	Multi-accel time 5	70	60000	0
A42B	42027	I43	Multi-decel time 5	70	60000	0
A42C	42028	I44	Multi-accel time 6	80	60000	0
A42D	42029	I45	Multi-decel time 6	80	60000	0
A42E	42030	I46	Multi-accel time 7	90	60000	0
A42F	42031	I47	Multi-decel time 7	90	60000	0
A432	42034	I50	Analogue output mode	0	3	0
A433	42035	I51	Analogue output setting	100	200	10
A434	42036	I52	Level of frequency detection	3000	Max. Freq.	0
A435	42037	I53	Bandwidth of frequency detection	1000	Max. Freq.	0
A436	42038	I54	Multi-function output (MO) configuration	12	19	0
A437	42039	I55	Multi-function relay (3A, B, C) configuration	17	19	0
A438	42040	I56	Fault relay configuration	2	7	0

Address		Param.	Description	Default value	Range	
16 bit	10 bit				Max.	Min.
A439	42041	I57	Output configuration when communication error occurs	0	3	0
A43B	42043	I59	Selection of communication protocol	0	1	0
A43C	42044	I60	Slave number in communication net	1	250	1
A43D	42045	I61	Transmission speed in communication net	3	4	0
A43E	42046	I62	Stop mode after reference signal loss	0	2	0
A43F	42047	I63	Time to determine speed reference signal loss	10	1200	1
A440	42048	I64	Communication time setting	5	100	2
A441	42049	I65	Parity/Stop bit setting	0	3	0
A442	42050	I66	Read address register 1	5	42239	0
A443	42051	I67	Read address register 2	6	42239	0
A444	42052	I68	Read address register 3	7	42239	0
A445	42053	I69	Read address register 4	8	42239	0
A446	42054	I70	Read address register 5	9	42239	0
A447	42055	I71	Read address register 6	10	42239	0
A448	42056	I72	Read address register 7	11	42239	0
A449	42057	I73	Read address register 8	12	42239	0
A44A	42058	I74	Write address register 1	5	42239	0
A44B	42059	I75	Write address register 2	6	42239	0
A44C	42060	I76	Write address register 3	7	42239	0
A44D	42061	I77	Write address register 4	8	42239	0
A44E	42062	I78	Write address register 5	9	42239	0

Address		Param.	Description	Default value	Range	
16 bit	10 bit				Max.	Min.
A44F	42063	I79	Write address register 6	10	42239	0
A450	42064	I80	Write address register 7	11	42239	0
A451	42065	I81	Write address register 8	12	42239	0
A452	42066	I82	Brake open current	500	1800	0
A453	42067	I83	Brake open delay time	10	100	0
A454	42068	I84	Brake open FX frequency	100	40000	0
A455	42069	I85	Brake open RX frequency	100	40000	0
A456	42070	I86	Brake close delay time	10	100	0
A457	42071	I87	Brake close frequency	200	40000	0
A458	42072	I88	Fire mode frequency	5000	Max. Freq.	0
A459	42073	I89	Minimum scaling factor for PID feedback	0	1000	0
A45A	42074	I90	Maximum scaling factor for PID feedback	1000	1000	0
A45B	42075	I91	Selection of contact type A or B for multi-function output	0	1	0
A45C	42076	I92	On delay time for multi-function output	0	100	0
A45D	42077	I93	Off delay time for multi-function output	0	100	0
A45E	42078	I94	On delay time for multi-function relay	0	100	0
A45F	42079	I95	Off delay time for multi-function relay	0	100	0
A460	42080	I96	Fire mode	0	1	0

10.6. Faults solution

Check points	Corrective measures
Is the power provided the converter?	Provide electric power to the converter.
Are the connections between converter and computer correct?	Refer to converter manual.
Is the connection between converter and communication card right?	Check the wiring (see '10.3 Installation').
Is the communication port selected correctly from the user program?	Verify the selected communication port is the same port used to communicate.
Is master not polling?	Verify the master is polling the inverter.
Is baud rate of the computer and inverter correctly set?	Set the correct value in accordance with '10.3 Installation'.
Is the data format of user program right?	Revise user program.

11. OPTIONS

11.1. Filters

11.1.1. RFI Filters

Reference	Current I(A)	Leakage Current I(mA)		Voltage (V)	Applicable Inverters
		Rated	Maximum		
FESD25302	5	0.5	26	250	SD25203 SD25205
				400	SD25301 SD25302
FESD25208	12	0.5	26	250	SD25208
FESD25304	6	0.5	26	400	SD25304
FESD25217	20	0.5	26	250	SD25212 SD25217
FESD25309	11	0.5	26	400	SD25306 SD25309
FESD25232	50	0.5	26	250	SD25224 SD25232
FESD25316	30	0.5	26	400	SD25312 SD25316
FESD25260	65	3.2	34	480	SD25246 SD25260
FESD25330	35	3.2	34	480	SD25324 SD25330
FESD25288	90	3.2	34	480	SD25274 SD25288
FESD25345	45	3.2	34	480	SD25339 SD25345

Dimensions for RFI Filters

Reference	Dimensions for Filters (mm)					Net Weight (kg)	Applicable Inverters
	L	Y	W	X	H		
FESD25302	175	161	76.5	53	40	1.2	SD25203, SD25205 SD25301, SD25302
FESD25208	176.5	162.5	107.5	84	40	1.3	SD25208
FESD25304	176.5	162.5	107.5	84	40	1.3	SD25304
FESD25217	176.5	162.5	147.5	124	45	1.8	SD25212, SD25217
FESD25309	176.5	162.5	147.5	124	45	1.8	SD25306, SD25309
FESD25232	270	252	189.5	162	60	2.5	SD25224, SD25232
FESD25316	270	252	189.5	162	60	2.5	SD25312, SD25316
FESD25260	418	398	255	177	65	-	SD25246, SD25260
FESD25330	418	398	255	177	65	-	SD25324, SD25330
FESD25288	506	486	280	200	65	-	SD25274, SD25288
FESD25345	506	486	280	200	65	-	SD25339, SD25345

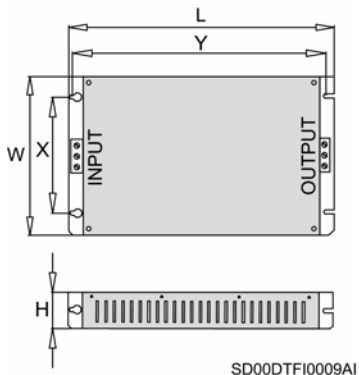

Figure 11.1 Dimensions for RFI Filters

11.1.2. Input harmonics filters

Reference	Current I(A)	Voltage (V)	Dimensions (mm)			Applicable Inverters
			H	W	D	
FHSD4004	4	400	230	170	120	SD25301, SD25302 SD25304
FHSD4008	8	400	230	170	120	SD25306
FHSD4016	16	400	230	170	120	SD25309, SD25312 SD25316
FHSD4024	24	400	320	140	100	SD25324
FHSD4030	30	400	320	140	100	SD25330
FHSD4045	45	400	320	230	100	SD25339, SD25345

11.1.3. dV/dt output filters

Model	Reference	Current I(A)	Dimensions (mm)						Applicable Inverters
			H	W	D	X	Y	Z	
1 (IP00)	FSDVDT-030	30	150	80	135	-	-	-	SD25203, SD25205 SD25208, SD25212 SD25217, SD25224 SD25232 SD25301, SD25302 SD25304, SD25306 SD25309, SD25312, SD25316, SD25324, SD25330
	FSDVDT-050	50	150	95	135	-	-	-	SD25246, SD25339 SD25345
	FSDVDT-070	70	150	95	135	-	-	-	SD25260
	FSDVDT-100	100	180	85	160	-	-	-	SD25274, SD25288
2 (IP23)	FSDVDT-030-23	30	220	200	215	195	85	85	SD25203, SD25205 SD25208, SD25212 SD25217, SD25224 SD25232 SD25301, SD25302 SD25304, SD25306 SD25309, SD25312, SD25316, SD25324, SD25330
	FSDVDT-050-23	50	220	200	215	195	85	85	SD25246, SD25339 SD25345
	FSDVDT-070-23	70	220	200	215	195	85	85	SD25260
	FSDVDT-100-23	100	220	200	215	195	85	85	SD25274, SD25288

Note: For large cable lengths between the drive and motor, contact with Technical Department from Power Electronics.

Dimensions for dV/dt output filters**MODEL 1 (IP00)**

Figure 11.2 Dimensions for dV/dt Filters – Model 1 (IP00)

MODEL 2 (IP23)

Figure 11.3 Dimensions for dV/dt Filters – Model 2 (IP23)

11.2. Braking resistors

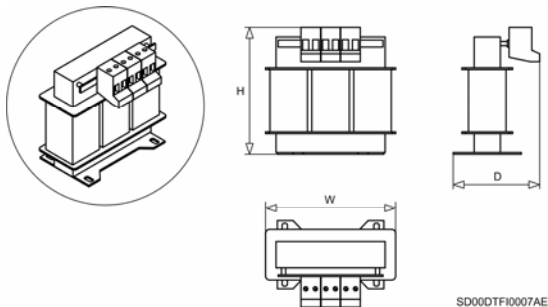
Reference	Input voltage (V)	Inverter capacity (kW)	100% Braking		150% Braking	
			Ω	W*	Ω	W*
SD25203	200	0.4	400	50	300	100
SD25205		0.75	200	100	150	150
SD25208		1.5	100	200	60	300
SD25212		2.2	60	300	50	400
SD25217		4	40	500	33	600
SD25224		5.5	30	700	20	800
SD25232		7.5	20	1000	15	1200
SD25246		11	15	1400	10	2400
SD25260		15	11	2000	8	2400
SD25274		18.5	9	2400	5	3600
SD25288		22	8	2800	5	3600
SD25301		400	0.4	1800	50	1200
SD25302	0.75		900	100	600	150
SD25304	1.5		450	200	300	300
SD25306	2.2		300	300	200	400
SD25309	4		200	500	130	600
SD25312	5.5		120	700	85	1000
SD25316	7.5		90	1000	60	1200
SD25324	11		60	1400	40	2000
SD25330	15		45	2000	30	2400
SD25339	18.5		35	2400	20	3600
SD25345	22		30	2800	10	3600

Note: The values of the braking resistors that appear in the table are the minimum values recommended. For a customized calculation and adjusted to your application consult with Power Electronics.

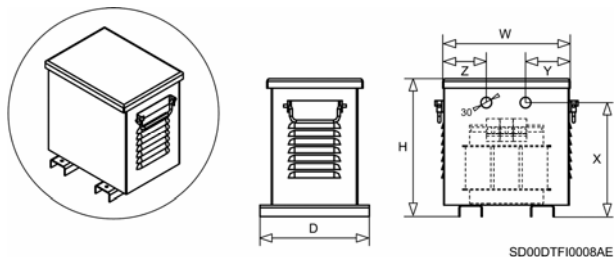
* Power is based on 5% of enable duty with continuous braking during 15 seconds.

11.3. Conduit Box

The next table indicates the model of the box corresponding to each inverter:

Conduit Box	Inverter Frame	Inverter
MODEL 1	1	SD25203
		SD25205
		SD25301
		SD25302
MODEL 2	2	SD25208
		SD25304
MODEL 3	3	SD25212
		SD25217
		SD25306
		SD25309
MODEL 4	4	SD25224
		SD25232
		SD25312
		SD25316
MODEL 5	5	SD25246
		SD25260
		SD25324
		SD25330
MODEL 6	6	SD25274
		SD25288
		SD25339
		SD25345

11.3.1. Dimensions of Conduit Box Model 1

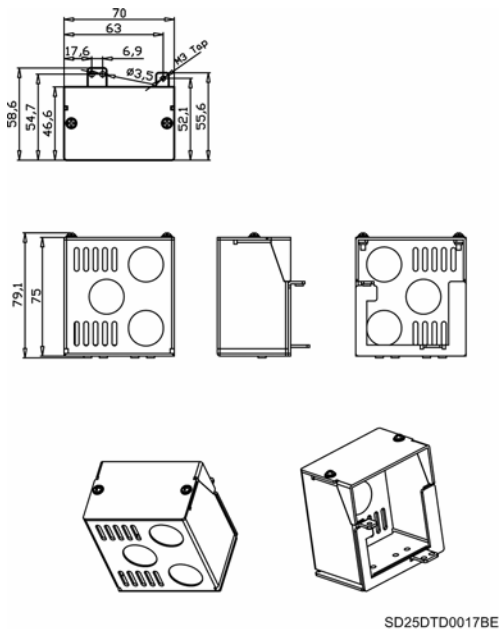

Figure 11.4 Dimensions of Conduit Box Model 1

11.3.2. Dimensions of Conduit Box Model 2

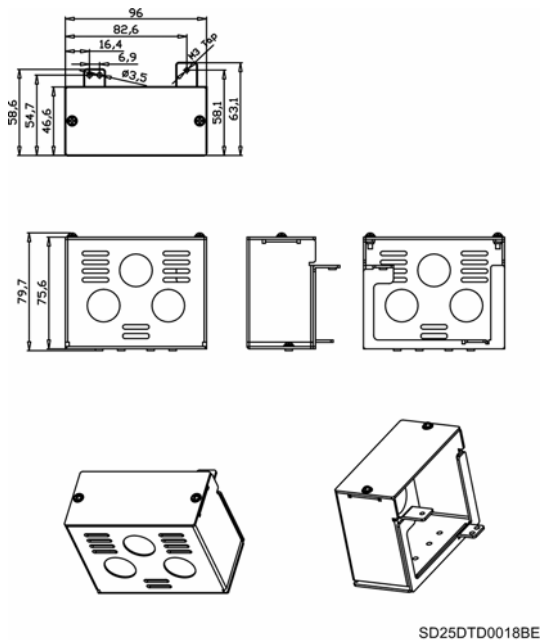

Figure 11.5 Dimensions of Conduit Box Model 2

11.3.3. Dimensions of Conduit Box Model 3

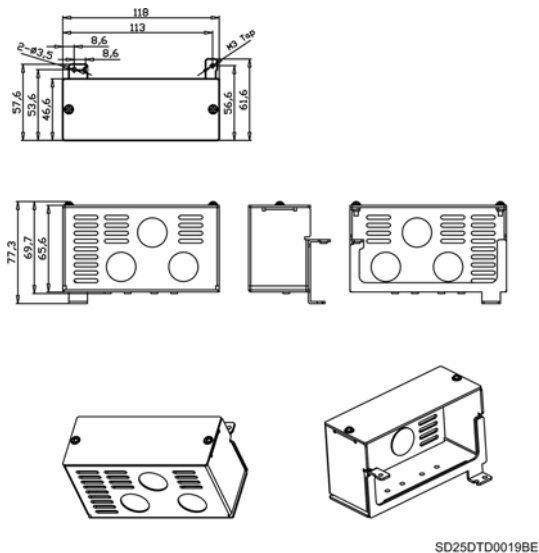

Figure 11.6 Dimensions of Conduit Box Model 3

11.3.4. Dimensions of Conduit Box Model 4

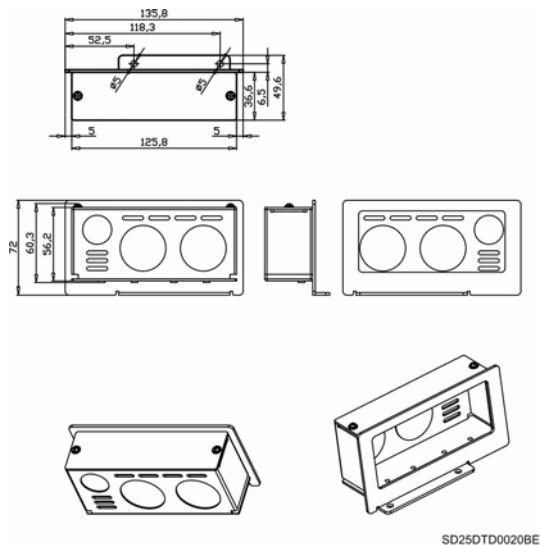
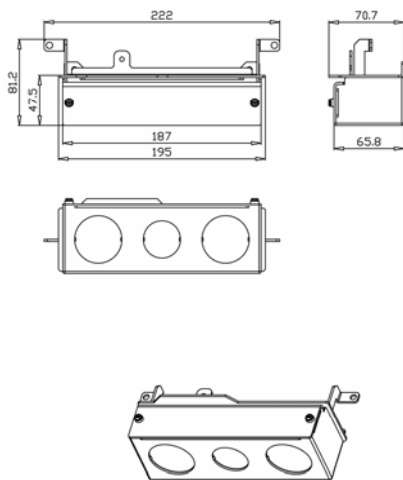

Figure 11.7 Dimensions of Conduit Box Model 4

11.3.5. Dimensions of Conduit Box Model 5



SD25DTD0030BE

Figure 11.8 Dimensions of Conduit Box Model 5

11.3.6. Dimensions of Conduit Box Model 6

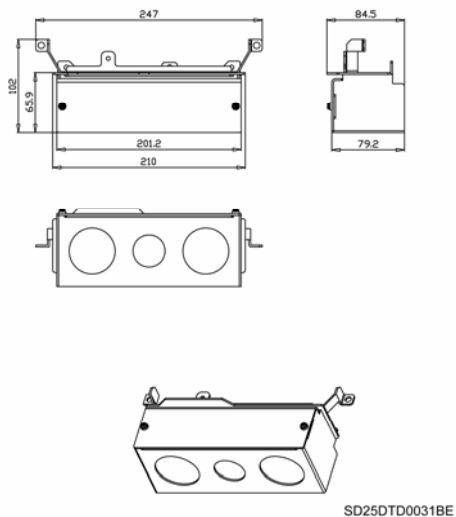

Figure 11.9 Dimensions of Conduit Box Model 6

11.3.7. Installation

Installation for Conduit Box from Model 1 to Model 3:

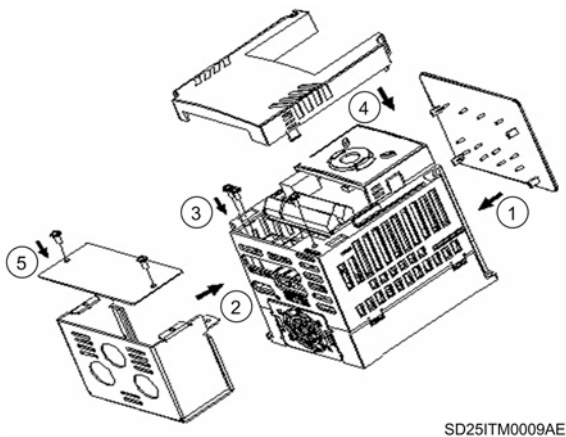
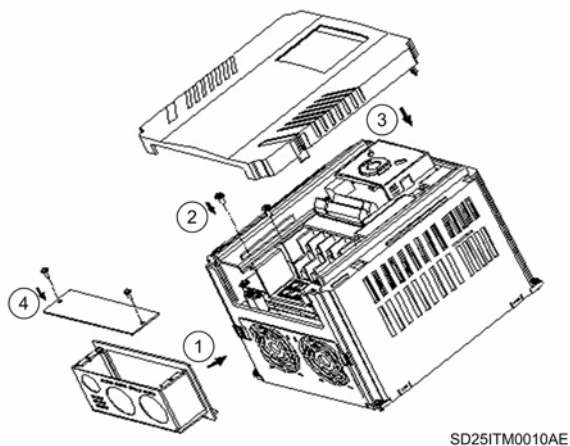

Figure 11.10 Installation for Conduit Box from Model 1 to Model 3

Installation for Conduit Box Model 4:

*Figure 11.11 Installation for Conduit Box Model 4*

Installation for Conduit Box Models 5 and 6:

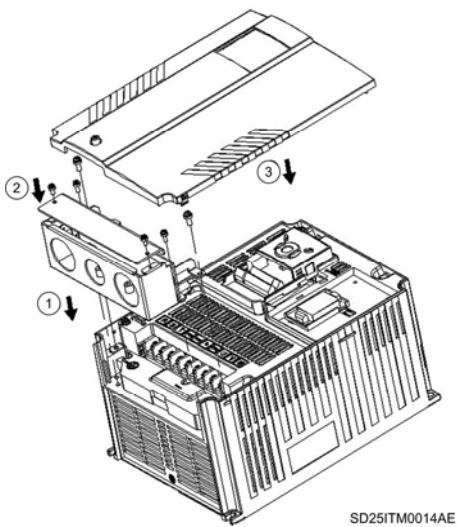
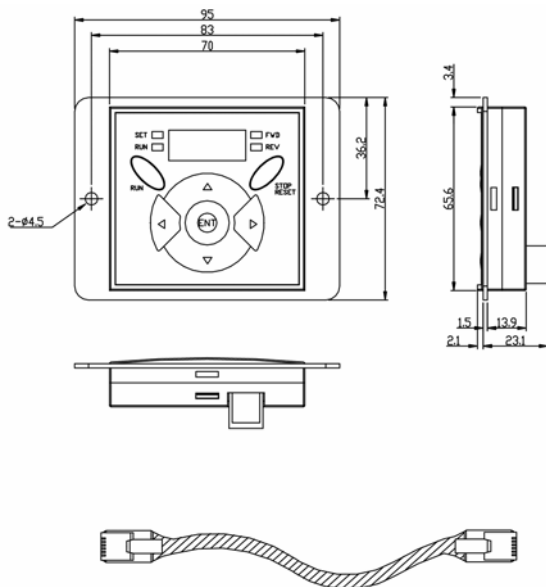

Figure 11.12 Installation for Conduit Box Models 5 and 6

11.4. Remote keypad / display unit

Reference	Description
SD25CF1	Remote keypad / display unit + remote cable 5 meters



SD25DTD0021AE

Figure 11.13 Remote keypad / display unit and remote cable

11.4.1. Installation

- 1) Take off the top cover and remove the hole cover on the side of the keypad / display unit integrated in the equipment to connect the remote cable.

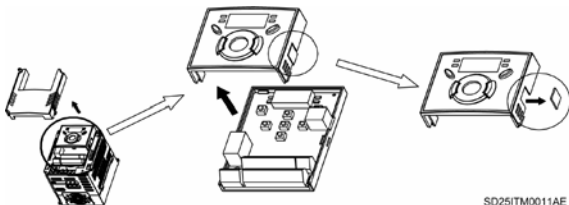

Figure 11.14 Installation of remote keypad / display unit. Step 1

- 2) Connect the remote cable as shown below and replace the top cover.

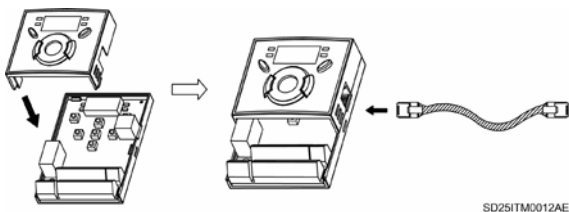
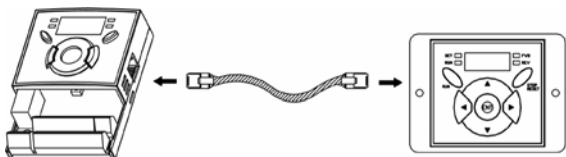

Figure 11.15 Installation of remote keypad / display unit. Step 2

- 3) Connect the other side of the remote cable to the remote keypad / display unit.



SD25ITM0013AE

Figure 11.16 Installation of remote keypad / display unit. Step 3

Use precautions

- Parameter read is not available until parameter write is executed since the memory of the remote unit is empty at the beginning.
- Do not use a remote cable different to the cable supplied by Power Electronics. Otherwise, malfunction may occur due to noise input or voltage drop in the remote unit.
- Check the connection of the remote cable if '----' is displayed in the remote unit.

12. COMMONLY USED CONFIGURATIONS

Caution: The following instructions are based on the fact of all parameters are set to the factory default values. Results may be different if parameter values are modified. In this case, initialize the values of all parameters to return to the default values and follow the instructions below.

12.1. Start/Stop commands by terminals and speed setting by analogue input

12.1.1. Parameters configuration

Parameter	Default value	Description	Set value
0.00	0.00Hz	Reference frequency	x.xxHz (The value of the reference frequency set by analogue input V1 or I will be displayed).
ACC	5.0 sec	Acceleration time	10.0 sec
dEC	10.0 sec	Deceleration time	10.0 sec
drv	1	Drive mode	1: Run/Stop by terminals FX – Forward or Rx – Reverse.
frq	0	Frequency setting mode	3: V1 (Potentiometer, VR, V1 and CM terminals). 4: I (analogue current input, CM and I terminals).
F4	0	Stop mode	0: Decelerate to stop. 1: DC brake to stop. 2: Free run to stop.
F21	50.00Hz	Maximum frequency	50.00Hz
F22	50.00Hz	Base frequency	50.00Hz

Parameter	Default value	Description	Set value								
F23	0.50Hz	Start frequency	0.10Hz (Minimum speed at the start).								
F24	0	Frequency limits selection	0: NO (Limits are established by max. freq. and start freq.). 1: YES (Limits are established by high and low frequency limits).								
F25	50.00Hz	High frequency limit	50.00Hz								
F26	0.50Hz	Low frequency limit	0.00Hz								
F27	0	Torque boost selection	0: Manual torque boost (Settable in two motor rotation directions separately, in 'F28 → Torque boost in forward direction' and in 'F29 → Torque boost in reverse direction'). 1: Auto torque boost. The inverter calculates automatically the torque boost based on motor parameters.								
H20	0	Restart after power supply fault	0: NO (Does not restart after power supply fault). 1: YES (Restart after power supply fault).								
H21	0	Restart after fault reset	0: NO 1: YES								
H30	*	Motor power setting	<table border="1"> <tbody> <tr> <td>0.2</td> <td>0.2kW</td> </tr> <tr> <td>"</td> <td>"</td> </tr> <tr> <td>5.5</td> <td>5.5kW</td> </tr> <tr> <td>7.5</td> <td>7.5kW</td> </tr> </tbody> </table>	0.2	0.2kW	"	"	5.5	5.5kW	7.5	7.5kW
0.2	0.2kW										
"	"										
5.5	5.5kW										
7.5	7.5kW										
H33	*	Motor rated current	?A (See motor nameplate).								
H39	3kHz	Setting of Carrier frequency	5kHz								
H79	EU 2.x	Software Version	-								
H93	0	Parameters initialize	1: All parameter groups are initialized to factory default value (only if as required).								

Parameter	Default value	Description	Set value
I6	10	Filter time constant for analogue voltage of V1 input	10ms (Filter for analogue voltage input).
I7	0V	Minimum voltage of V1 input	0.00V (Setting of minimum voltage V1 input).
I8	0.00	Minimum freq. for V1 input at min. voltage	0.00Hz (the output minimum frequency at minimum voltage of the V1 input).
I9	10V	Maximum voltage of V1 input	10.0V (setting of maximum voltage V1 input).
I10	50.00Hz	Maximum freq. for V1 input at max. voltage	50.00Hz (the output maximum frequency at minimum voltage of the V1 input).
I11	10ms	Filter time constant for analogue current of I input	10ms (Filter for analogue current input).
I12	4.00mA	Minimum current of I input	4.00mA (Setting of minimum current I input).
I13	0.00Hz	Minimum freq. for I input at min. voltage	0.00Hz (the output minimum frequency at minimum current of the I input).
I14	20.00mA	Maximum current of I input	20.00mA (Setting of maximum current I input).
I15	50.00Hz	Maximum freq. for I input at max. voltage	50.00Hz (The output maximum frequency at maximum current of the I input).
I17	0	Configuration of multi-function digit. Input P1	0: Forward Run command (FX).

12.1.2. Connections drawing

Terminals CM/P1:	Run command (NO status).
Terminals I/CM:	4 – 20mA analogue input.
Terminals VR/V1/CM:	0 – 10V analogue input.

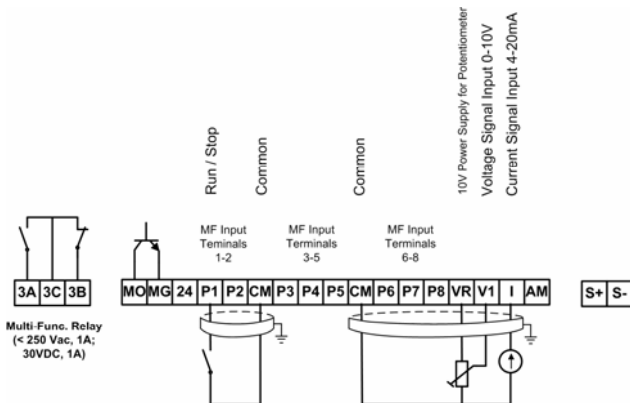

SD25DTC0006A1

Figure 12.1 Start/Stop commands by terminals and speed setting by analogue input

12.2. Start/Stop commands by keypad and speed setting by analogue input

12.2.1. Parameters configuration

Parameter	Default value	Description	Set value
0.00	0.00Hz	Reference frequency	x.xxHz (The value of the reference frequency set by analogue input V1 or I will be displayed).
ACC	5.0 sec	Acceleration time	10.0 sec
dEC	10.0 sec	Deceleration time	10.0 sec
drv	1	Drive mode	0: Setting by keypad (RUN/STOP keys).
frq	0	Frequency setting mode	3: V1 (Potentiometer, VR, V1 and CM terminals). 4: I (analogue current input, CM and I terminals).
F4	0	Stop mode	0: Decelerate to stop. 1: DC brake to stop. 2: Free run to stop.
F21	50.00Hz	Maximum frequency	50.00Hz
F22	50.00Hz	Base frequency	50.00Hz
F23	0.50Hz	Start frequency	0.10Hz (Minimum speed at the start).
F24	0	Frequency limits selection	0: NO (Limits are established by max. freq. and start freq.). 1: YES (Limits are established by high and low frequency limits).
F25	50.00Hz	High frequency limit	50.00Hz
F26	0.50Hz	Low frequency limit	0.00Hz
F27	0	Torque boost selection	0: Manual torque boost (Settable in two motor rotation directions separately, in 'F28 → Torque boost in forward direction' and in 'F29 → Torque boost in reverse direction'). 1: Auto torque boost. The inverter calculates automatically the torque boost based on motor parameters.

Parameter	Default value	Description	Set value								
H20	0	Restart after power supply fault	0: NO (Does not restart after power supply fault). 1: YES (Restart after power supply fault).								
H21	0	Restart after fault reset	0: NO 1: YES								
H30	*	Motor power setting	<table border="1"> <tbody> <tr> <td>0.2</td> <td>0.2kW</td> </tr> <tr> <td>"</td> <td>"</td> </tr> <tr> <td>5.5</td> <td>5.5kW</td> </tr> <tr> <td>7.5</td> <td>7.5kW</td> </tr> </tbody> </table>	0.2	0.2kW	"	"	5.5	5.5kW	7.5	7.5kW
0.2	0.2kW										
"	"										
5.5	5.5kW										
7.5	7.5kW										
H33	*	Motor rated current	?A (See motor nameplate).								
H39	3kHz	Setting of Carrier frequency	5kHz								
H79	EU 2.x	Software Version	-								
H93	0	Parameters initialize	1: All parameter groups are initialized to factory default value (only if as required).								
I6	10	Filter time constant for analogue voltage of V1 input	10ms (Filter for analogue voltage input).								
I7	0V	Minimum voltage of V1 input	0.00V (Setting of minimum voltage V1 input).								
I8	0.00	Minimum freq. for V1 input at min. voltage	0.00Hz (the output minimum frequency at minimum voltage of the V1 input).								
I9	10V	Maximum voltage of V1 input	10.0V (setting of maximum voltage V1 input).								
I10	50.00Hz	Maximum freq. for V1 input at max. voltage	50.00Hz (the output maximum frequency at minimum voltage of the V1 input).								

Parameter	Default value	Description	Set value
I11	10ms	Filter time constant for analogue current of I input	10ms (Filter for analogue current input).
I12	4.00mA	Minimum current of I input	4.00mA (Setting of minimum current I input).
I13	0.00Hz	Minimum freq. for I input at min. voltage	0.00Hz (the output minimum frequency at minimum current of the I input).
I14	20.00mA	Maximum current of I input	20.00mA (Setting of maximum current I input).
I15	50.00Hz	Maximum freq. for I input at max. voltage	50.00Hz (The output maximum frequency at maximum current of the I input).

12.2.2. Connections drawing

Terminals I/CM: 4 – 20mA analogue input.
 Terminals VR/V1/CM: 0 – 10V analogue input.

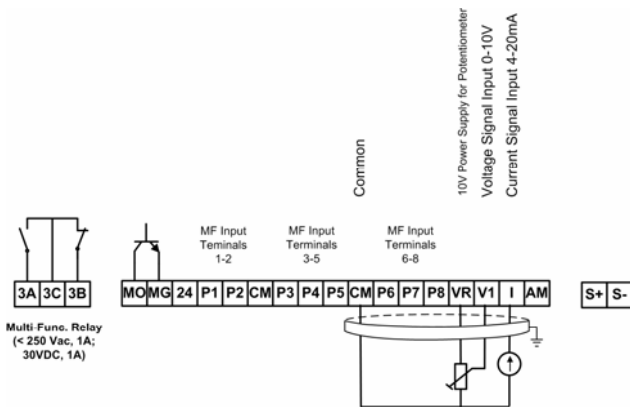

SD25DTC0007A1

Figure 12.2 Start/Stop commands by keypad and speed setting by analogue input

12.3. Multi-speed commands (multi-step frequencies) using P6, P7 and P8

12.3.1. Parameters configuration

Parameter	Default value	Description	Set value
0.00	0.00Hz	Reference frequency	50.00Hz (multi-speed 0).
ACC	5.0 sec	Acceleration time	10.0 sec
dEC	10.0 sec	Deceleration time	10.0 sec
drv	1	Drive mode	1: Run/Stop by terminals FX – Forward or Rx – Reverse.
frq	0	Frequency setting mode	0: Keypad.
st1	10.00Hz	Multi-step frequency 1	30.00Hz (multi-speed 1).
st2	20.00Hz	Multi-step frequency 2	35.00Hz (multi-speed 2).
st3	30.00Hz	Multi-step frequency 3	40.00Hz (multi-speed 3).
F21	50.00Hz	Maximum frequency	50.00Hz
F22	50.00Hz	Base frequency	50.00Hz
F23	0.50Hz	Start frequency	0.10Hz (Minimum speed at the starting).
F24	0	Frequency limits selection	0: NO (Limits are established by max. freq. and start freq.). 1: YES (Limits are established by high and low frequency limits).
F25	50.00Hz	High frequency limit	50.00Hz

Parameter	Default value	Description	Set value								
F26	0.50Hz	Low frequency limit	0.00Hz								
F27	0	Torque boost selection	0: Manual torque boost (Settable in two motor rotation directions separately, in 'F28 → Torque boost in forward direction' and in 'F29 → Torque boost in reverse direction'). 1: Auto torque boost. The inverter calculates automatically the torque boost based on motor parameters.								
H30	*	Motor power setting	<table border="1"> <tbody> <tr> <td>0.2</td> <td>0.2kW</td> </tr> <tr> <td>"</td> <td>"</td> </tr> <tr> <td>5.5</td> <td>5.5kW</td> </tr> <tr> <td>7.5</td> <td>7.5kW</td> </tr> </tbody> </table>	0.2	0.2kW	"	"	5.5	5.5kW	7.5	7.5kW
0.2	0.2kW										
"	"										
5.5	5.5kW										
7.5	7.5kW										
H33	*	Motor rated current	?A (See motor nameplate).								
H39	3kHz	Setting of Carrier frequency	5kHz								
I17	0	Configuration of multi-function digit. Input P1	0: Forward Run command (FX).								
I22	5	Configuration of multi-function digit. input P6	5: Low Speed (Low bit).								
I23	6	Configuration of multi-function digit. Input P7	6: Middle Speed (Middle bit).								
I24	7	Configuration of multi-function digit. input P8	7: High Speed (High bit).								
I30	30.00Hz	Multi-step frequency 4	45.00Hz (multi-speed 4).								
I31	25.00Hz	Multi-step frequency 5	50.00Hz (multi-speed 5).								
I32	20.00Hz	Multi-step frequency 6	47.00Hz (multi-speed 6).								
I33	15.00Hz	Multi-step frequency 7	42.00Hz (multi-speed 7).								

Depending on the status of P6, P7 and P8 input terminal we can select different programmed frequencies:

Programmed frequency	Parameter	High Speed (P8)	Middle Speed (P7)	Low Speed (P6)
50.00Hz	0.00	0	0	0
30.00Hz	st1	0	0	1
35.00Hz	st2	0	1	0
40.00Hz	st3	0	1	1
45.00Hz	I30	1	0	0
50.00Hz	I31	1	0	1
47.00Hz	I32	1	1	0
42.00Hz	I33	1	1	1

12.3.2. Connections drawing

Terminals CM/P1:	Run command (NO status).
Terminals CM/P6:	Low speed (Low bit) (NO status).
Terminals CM/P7:	Middle speed (Middle bit) (NO status).
Terminals CM/P8:	High speed (High bit) (NO status).

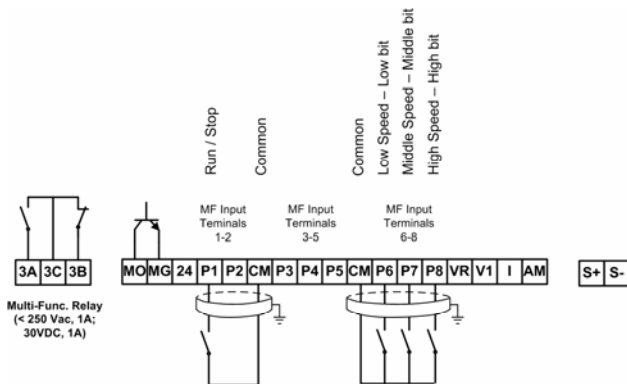

SD25DTC0008BI

Figure 12.3 Multi-speed commands using P6, P7 and P8

12.4. Constant pressure control and automatic stop at zero level flow. Pressure command set by keypad

12.4.1. Parameters configuration

Parameter	Default value	Description	Set value								
ACC	5.0 sec	Acceleration time	10.0 sec								
dEC	10.0 sec	Deceleration time	10.0 sec								
drv	1	Drive mode	1: Run/Stop by terminals FX – Forward or Rx – Reverse.								
frq	0	Frequency setting mode	0: Keypad.								
rEF	0.0	PID Reference	40.0 (Reference setting in % for PID control).								
Fbk	0.0	PID Feedback	x.x (It displays the feedback in % for PID control).								
F21	50.00Hz	Maximum frequency	50.00Hz								
F22	50.00Hz	Base frequency	50.00Hz								
F23	0.50Hz	Start frequency	0.10Hz (Minimum speed at the starting).								
F24	0	Frequency limits selection	0: NO (Limits are established by max. freq. and start freq.). 1: YES (Limits are established by high and low frequency limits).								
F25	50.00Hz	High frequency limit	50.00Hz								
F26	0.50Hz	Low frequency limit	0.00Hz								
F27	0	Torque boost selection	0: Manual torque boost (Settable in two motor rotation directions separately, in 'F28 → Torque boost in forward direction' and in 'F29 → Torque boost in reverse direction'). 1: Auto torque boost. The inverter calculates automatically the torque boost based on motor parameters.								
H30	*	Motor power setting	<table border="1"> <tbody> <tr> <td>0.2</td> <td>0.2kW</td> </tr> <tr> <td>"</td> <td>"</td> </tr> <tr> <td>5.5</td> <td>5.5kW</td> </tr> <tr> <td>7.5</td> <td>7.5kW</td> </tr> </tbody> </table>	0.2	0.2kW	"	"	5.5	5.5kW	7.5	7.5kW
0.2	0.2kW										
"	"										
5.5	5.5kW										
7.5	7.5kW										

Parameter	Default value	Description	Set value
H33	*	Motor rated current	?A (See motor nameplate).
H39	3kHz	Setting of Carrier frequency	5kHz
H49	0	PID control selection	1: PID control enabled.
H50	0	PID Feedback setting	0: I input (Feedback given by a 0 – 20mA signal).
H51	300.0	P gain for PID mode	300.0
H52	1.0	I gain for PID mode	1.0
H53	0.0	D gain for PID mode	0.0
H54	0	PID control mode selection	0: Normal PID control. 1: Process PID control.
H55	50.00	High limit of output frequency in PID mode	50.00Hz
H56	0.50	Low limit of output frequency in PID mode	10.00Hz
H57	0	PID reference mode setting	0: Setting by Keypad 1.
H61	60 sec	Sleep delay time	40 sec (Delay time to inverter stops).
H62	0.00Hz	Sleep frequency	10.00Hz (Frequency from which the stop condition is given).
H63	2%	Wake up level in Sleep mode	10% (% of feedback to restart).
H79	EU 2.x	Software Version	-

Parameter	Default value	Description	Set value
I11	10ms	Filter time constant for analogue current of I input	10ms (Filter for analogue current input).
I12	4.00mA	Minimum current of I input	4.00mA (Setting of minimum current I input).
I13	0.00Hz	Minimum freq. for I input at min. voltage	0.00Hz (the output minimum frequency at minimum current of the I input).
I14	20.00mA	Maximum current of I input	20.00mA (Setting of maximum current I input).
I15	50.00Hz	Maximum freq. for I input at max. voltage	50.00Hz (The output maximum frequency at maximum current of the I input).
I17	0	Configuration of multi-function digit. Input P1	0 : Forward Run command (FX).

12.4.2. Connections drawing

Terminals CM/P1:

Run command (NO status).

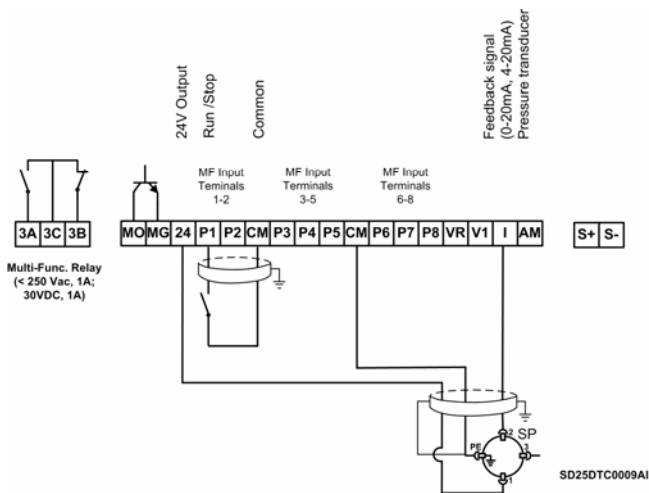

Figure 12.4 Constant pressure control and automatic stop at zero level flow.
Pressure command set by keypad

12.5. Automatic constant pressure control mode up to four reference frequencies and jog frequency as manual mode

12.5.1. Parameters configuration

Parameter	Default value	Description	Set value
ACC	5.0 sec	Acceleration time	10.0 sec
dEC	10.0 sec	Deceleration time	10.0 sec
drv	1	Drive mode	1: Run/Stop by terminals FX – Forward or Rx – Reverse.
frq	0	Frequency setting mode	0: Keypad.
st1	10.00Hz	Multi-step frequency 1	30.00Hz (Pressure command M1 → 60%).
st2	20.00Hz	Multi-step frequency 2	35.00Hz (Pressure command M2 → 70%).
st3	30.00Hz	Multi-step frequency 3	40.00Hz (Pressure command M3 → 80%).
rEF	0.0	PID Reference	40.0 (Reference setting in % for PID control).
Fbk	0.0	PID Feedback	x.x (It displays the feedback in % for PID control).
F20	10.00Hz	Jog frequency	30.00Hz (Set by user).
F21	50.00Hz	Maximum frequency	50.00Hz
F22	50.00Hz	Base frequency	50.00Hz
F23	0.50Hz	Start frequency	0.10Hz (Minimum speed at the start).
F24	0	Frequency limits selection	0: NO (Limits are established by max. freq. and start freq.). 1: YES (Limits are established by high and low frequency limits).
F25	50.00Hz	High frequency limit	50.00Hz

Parameter	Default value	Description	Set value								
F26	0.50Hz	Low frequency limit	0.00Hz								
F27	0	Torque boost selection	0: Manual torque boost (Settable in two motor rotation directions separately, in 'F28 → Torque boost in forward direction' and in 'F29 → Torque boost in reverse direction'). 1: Auto torque boost. The inverter calculates automatically the torque boost based on motor parameters.								
H30	*	Motor power setting	<table border="1"> <tbody> <tr> <td>0.2</td> <td>0.2kW</td> </tr> <tr> <td>"</td> <td>"</td> </tr> <tr> <td>5.5</td> <td>5.5kW</td> </tr> <tr> <td>7.5</td> <td>7.5kW</td> </tr> </tbody> </table>	0.2	0.2kW	"	"	5.5	5.5kW	7.5	7.5kW
0.2	0.2kW										
"	"										
5.5	5.5kW										
7.5	7.5kW										
H33	*	Motor rated current	?A (See motor nameplate).								
H39	3kHz	Setting of Carrier frequency	5kHz								
H49	0	PID control selection	1: PID control enabled.								
H50	0	PID Feedback setting	0: I input (Feedback given by a 0 – 20mA signal).								
H51	300.0	P gain for PID mode	300.0								
H52	1.0	I gain for PID mode	1.0								
H53	0.0	D gain for PID mode	0.0								
H54	0	PID control mode selection	0: Normal PID control. 1: Process PID control.								
H55	50.00	High limit of output frequency in PID mode	50.00Hz								
H56	0.50	Low limit of output frequency in PID mode	10.00Hz								
H57	0	PID reference mode setting	0: Setting by Keypad 1.								

Parameter	Default value	Description	Set value
H61	60 sec	Sleep delay time	40 sec (Delay time to inverter stops).
H62	0.00Hz	Sleep frequency	10.00Hz (Frequency from which the stop condition is given).
H63	2%	Wake up level in Sleep mode	10% (% of feedback to restart).
H79	EU 2.x	Software Version	-
I11	10ms	Filter time constant for analogue current of I input	10ms (Filter for analogue current input).
I12	4.00mA	Minimum current of I input	4.00mA (Setting of minimum current I input).
I13	0.00Hz	Minimum freq. for I input at min. voltage	0.00Hz (the output minimum frequency at minimum current of the I input).
I14	20.00mA	Maximum current of I input	20.00mA (Setting of maximum current I input).
I15	50.00Hz	Maximum freq. for I input at max. voltage	50.00Hz (The output maximum frequency at maximum current of the I input).
I17	0	Configuration of multi-function digit. Input P1	0: Forward Run command (FX).
I21	4	Configuration of multi-function digit. Input P5	4: Jog operation. Set to 30Hz before in F20 (Jog frequency).
I22	5	Configuration of multi-function digit. input P6	5: Low Speed (Pressure command – Low bit).
I23	6	Configuration of multi-function digit. Input P7	6: Middle Speed (Pressure command – Middle bit).

Programmed freq. (Pressure command)	Param.	Middle Speed (P7)	Low Speed (P6)	Command
40.0%	rEF	0	0	M0
30.00Hz → 60.0%	st1	0	1	M1
35.00Hz → 70.0%	st2	1	0	M2
40.00Hz → 80.0%	st3	1	1	M3

12.5.2. Connections drawing

Terminals CM/P1:	Run command (NO status).
Terminals CM/P5 – JOG:	Jog Frequency (set before).
Terminals CM/P6:	Pressure command (Low bit) (NO).
Terminals CM/P7:	Pressure command (Middle bit) (NO).
Terminals CM/P8:	Change to jog operation (manual mode) (NO).

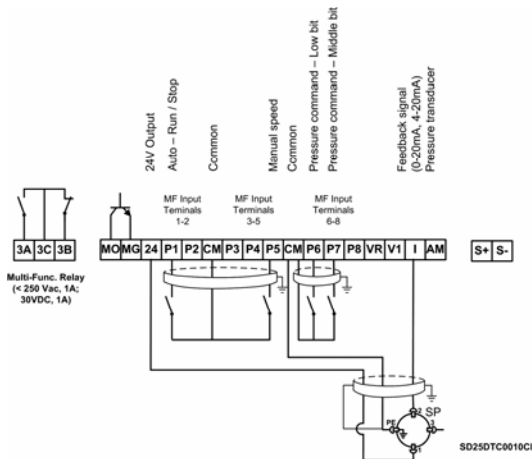

Figure 12.5 Automatic constant pressure control mode up to four reference frequencies and jog frequency as manual mode (set by keypad)

12.6. Constant pressure control up to eight commands and automatic stop at zero level flow. No jog frequency function at manual mode

12.6.1. Parameters configuration

Parameter	Default value	Description	Set value
ACC	5.0 sec	Acceleration time	10.0 sec
dEC	10.0 sec	Deceleration time	10.0 sec
drv	1	Drive mode	1: Run/Stop by terminals FX – Forward or Rx – Reverse.
frq	0	Frequency setting mode	0: Keypad.
st1	10.00Hz	Multi-step frequency 1	30.00Hz (Pressure command M1 → 60%).
st2	20.00Hz	Multi-step frequency 2	35.00Hz (Pressure command M2 → 70%).
st3	30.00Hz	Multi-step frequency 3	40.00Hz (Pressure command M3 → 80%).
rEF	0.0	PID Reference	40.0 (Reference setting in % for PID control).
Fbk	0.0	PID Feedback	x.x (It displays the feedback in % for PID control).
F21	50.00Hz	Maximum frequency	50.00Hz
F22	50.00Hz	Base frequency	50.00Hz
F23	0.50Hz	Start frequency	0.10Hz (Minimum speed at the start).
F24	0	Frequency limits selection	0: NO (Limits are established by max. freq. and start freq.). 1: YES (Limits are established by high and low frequency limits).
F25	50.00Hz	High frequency limit	50.00Hz
F26	0.50Hz	Low frequency limit	0.00Hz

Parameter	Default value	Description	Set value								
F27	0	Torque boost selection	0: Manual torque boost (Settable in two motor rotation directions separately, in 'F28 → Torque boost in forward direction' and in 'F29 → Torque boost in reverse direction'). 1: Auto torque boost. The inverter calculates automatically the torque boost based on motor parameters.								
H30	*	Motor power setting	<table border="1"> <tbody> <tr> <td>0.2</td> <td>0.2kW</td> </tr> <tr> <td>"</td> <td>"</td> </tr> <tr> <td>5.5</td> <td>5.5kW</td> </tr> <tr> <td>7.5</td> <td>7.5kW</td> </tr> </tbody> </table>	0.2	0.2kW	"	"	5.5	5.5kW	7.5	7.5kW
0.2	0.2kW										
"	"										
5.5	5.5kW										
7.5	7.5kW										
H33	*	Motor rated current	?A (See motor nameplate).								
H39	3kHz	Setting of Carrier frequency	5kHz								
H49	0	PID control selection	1: PID control enabled.								
H50	0	PID Feedback setting	0: I input (Feedback given by a 0 – 20mA signal).								
H51	300.0	P gain for PID mode	300.0								
H52	1.0	I gain for PID mode	1.0								
H53	0.0	D gain for PID mode	0.0								
H54	0	PID control mode selection	0: Normal PID control. 1: Process PID control.								
H55	50.00	High limit of output frequency in PID mode	50.00Hz								
H56	0.50	Low limit of output frequency in PID mode	10.00Hz								
H57	0	PID reference mode setting	0: Setting by Keypad 1.								
H61	60 sec	Sleep delay time	40 sec (Delay time to inverter stops).								
H62	0.00Hz	Sleep frequency	10.00Hz (Frequency from which the stop condition is given).								

Parameter	Default value	Description	Set value
H63	2%	Wake up level in Sleep mode	10% (% of feedback to restart).
H79	EU 2.x	Software Version	-
I11	10ms	Filter time constant for analogue current of I input	10ms (Filter for analogue current input).
I12	4.00mA	Min. current of I input	4.00mA (Setting of minimum current I input).
I13	0.00Hz	Minimum freq. for I input at min. voltage	0.00Hz (the output minimum frequency at minimum current of the I input).
I14	20.00mA	Max. current of I input	20.00mA (Setting of maximum current I input).
I15	50.00Hz	Maximum freq. for I input at max. voltage	50.00Hz (The output maximum frequency at maximum current of the I input).
I17	0	Configuration of multi-function digit. Input P1	0: Forward Run command (FX).
I22	5	Configuration of multi-function digit. input P6	5: Low Speed (Pressure command – Low bit).
I23	6	Configuration of multi-function digit. Input P7	6: Middle Speed (Pressure command – Middle bit).
I24	7	Configuration of multi-function digit. input P8	7: High Speed (Pressure command – High bit).
I30	30.00Hz	Multi-step frequency 4	45.00Hz (Pressure command M4 → 90%).
I31	25.00Hz	Multi-step frequency 5	50.00Hz (Pressure command M5 → 100%).
I32	20.00Hz	Multi-step frequency 6	47.00Hz (Pressure command M6 → 94%).
I33	15.00Hz	Multi-step frequency 7	42.00Hz (Pressure command M7 → 84%).

Programmed Freq. (Pressure command)	Param.	High Speed (P8)	Middle Speed (P7)	Low Speed (P6)	Command
40.0%	rEF	0	0	0	M0
30.00Hz → 60.0%	st1	0	0	1	M1
35.00Hz → 70.0%	st2	0	1	0	M2
40.00Hz → 80.0%	st3	0	1	1	M3
45.00Hz → 90.0%	I30	1	0	0	M4
50.00Hz → 100.0%	I31	1	0	1	M5
47.00Hz → 94.0%	I32	1	1	0	M6
42.00Hz → 84.0%	I33	1	1	1	M7

12.6.2. Connections drawing

Terminals CM/P1:	Run command (NO status).
Terminals CM/P6:	Pressure command (Low bit) (NO).
Terminals CM/P7:	Pressure command (Middle bit) (NO).
Terminals CM/P8:	Pressure command (High bit) (NO).

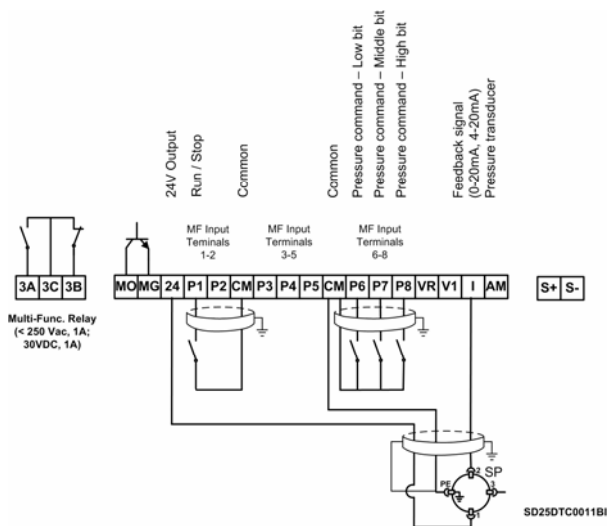

Figure 12.6 Constant pressure control up to eight commands and automatic stop at zero level flow. No jog frequency function at manual mode

12.7. Speed control (up/down potentiometer) and Start/Stop commands by terminals

12.7.1. Parameters configuration

Parameter	Default value	Description	Set value
0.00	0.00Hz	Reference frequency	x.xxHz (Visualization of the speed reference set by means of the Up/Down push-buttons).
ACC	5.0 sec	Acceleration time	30.0 sec (It determines the potentiometer ramp).
dEC	10.0 sec	Deceleration time	30.0 sec
drv	1	Drive mode	1: Run/Stop by terminals FX – Forward or Rx – Reverse.
frq	0	Frequency setting mode	8: Motorized Potentiometer (Up/Down mode).
F21	50.00Hz	Maximum frequency	50.00Hz
F22	50.00Hz	Base frequency	50.00Hz
F23	0.50Hz	Start frequency	0.10Hz (Minimum speed at the start).
F24	0	Frequency limits selection	0: NO (Limits are established by max. freq. and start freq.). 1: YES (Limits are established by high and low frequency limits).
F25	50.00Hz	High frequency limit	50.00Hz
F26	0.50Hz	High frequency limit	25.00Hz
F27	0	Torque boost selection	0: Manual torque boost (Settable in two motor rotation directions separately, in 'F28 → Torque boost in forward direction' and in 'F29 → Torque boost in reverse direction'). 1: Auto torque boost. The inverter calculates automatically the torque boost based on motor parameters.

Parameter	Default value	Description	Set value								
F63	0	Save Up/Down frequency select	0: NO (The reference frequency set by motorized potentiometer is not memorized). 1: YES (The reference frequency set by motorized potentiometer is memorized).								
F64	-	Saved frequency in Up/Down mode	It shows the memorized reference value if 'H63' is set to '1'.								
F65	0	Up/Down mode selection	0: The reference frequency is increased up to maximum frequency or decreased down to minimum frequency respecting high and low frequency limits.								
H30	*	Motor power setting	<table border="1"> <tbody> <tr> <td>0.2</td> <td>0.2kW</td> </tr> <tr> <td>"</td> <td>"</td> </tr> <tr> <td>5.5</td> <td>5.5kW</td> </tr> <tr> <td>7.5</td> <td>7.5kW</td> </tr> </tbody> </table>	0.2	0.2kW	"	"	5.5	5.5kW	7.5	7.5kW
0.2	0.2kW										
"	"										
5.5	5.5kW										
7.5	7.5kW										
H33	*	Motor rated current	?A (See motor nameplate).								
H79	EU 2.x	Software Version	-								
I17	0	Configuration of multi-function digit. Input P1	0: Forward Run command (FX).								
I22	5	Configuration of multi-function digit. input P6	17: 3-wire operation (Start/Stop by NC push button).								
I23	6	Configuration of multi-function digit. Input P7	15: Up frequency (NO push button to increase speed).								
I24	7	Configuration of multi-function digit. input P8	16: Down frequency (NO push button to decrease speed).								

Run command will be given with a NO push buttons between CM and P1 (FX) terminals. When run command (FX) is activated (CM common), the inverter will start and will keep the speed at 0Hz. When P7 push button is pressed, the speed increases up to minimum speed (F24), and if P7 follows pressed, the speed will follow increasing according to ACC acceleration ramp.

12.7.2. Connections drawing

Terminals CM/P1:	Run command (NO status).
Terminals CM/P7:	Up frequency push button (NO status).
Terminals CM/P8:	Down frequency push button (NO status).

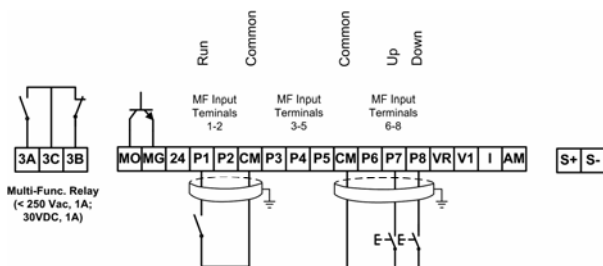

SD250TC0012BI

Figure 12.7 Speed control (up/down potentiometer) and Start/Stop commands by terminals

13. CONFIGURATION REGISTER

VARIABLE SPEED DRIVE: SD250.
 SERIAL No: MODEL:
 APPLICATION:
 DATE:
 CUSTOMER:
 NOTES:

PARAMETER / DESCRIPTION	DEFAULTS SETTINGS	SETTING 1	SETTING 2
DRIVE group (DRV)			
0.00 Reference frequency	0.00Hz	_____	_____
ACC Acceleration time	5.0 sec	_____	_____
dEC Deceleration time	10.0 sec	_____	_____
drv Drive mode	1	_____	_____
Frq Frequency setting mode	0	_____	_____
St1 Multi-step frequency 1	10.00Hz	_____	_____
St2 Multi-step frequency 2	20.00Hz	_____	_____
St3 Multi-step frequency 3	30.00Hz	_____	_____

PARAMETER / DESCRIPTION	DEFAULT SETTINGS	SETTING 1	SETTING 2
CUr Output current	-	_____	_____
rPM Motor RPM	-	_____	_____
dCL Inverter DC Link voltage	-	_____	_____
vOL User display selection	vOL	_____	_____
nOn Fault display	-	_____	_____
drC Selection of motor rotation direction	F	_____	_____
drv2 Drive mode 2	1	_____	_____
Frq2 Frequency setting mode 2	0	_____	_____
Frq3 Frequency setting mode 3	0	_____	_____
rEF PID Reference	-	_____	_____
Fbk PID Feedback	-	_____	_____
FUNCTION 1 group (F)			
F0 Parameter jump	0	_____	_____
F1 Prevention of motor rotation direction	0	_____	_____

PARAMETER / DESCRIPTION	DEFAULT SETTINGS	SETTING 1	SETTING 2
F2 Acceleration pattern	0	_____	_____
F3 Deceleration pattern	0	_____	_____
F4 Stop mode	0	_____	_____
F8 DC Brake start frequency	5.00Hz	_____	_____
F9 DC current application delay time	0.1 sec	_____	_____
F10 DC current level for DC brake	50%	_____	_____
F11 DC current application time	1.0 sec	_____	_____
F12 DC current level before starting	50%	_____	_____
F13 DC current application time before starting	0 sec	_____	_____
F14 Time for magnetizing a motor	1.0 sec	_____	_____
F20 Jog frequency	10.00Hz	_____	_____
F21 Maximum frequency	50.00Hz	_____	_____

PARAMETER / DESCRIPTION	DEFAULT SETTINGS	SETTING 1	SETTING 2
F22 Base frequency	50.00Hz	_____	_____
F23 Start frequency	0.50Hz	_____	_____
F24 Frequency limits selection	0	_____	_____
F25 High frequency limit	50.00Hz	_____	_____
F26 Low frequency limit	0.50Hz	_____	_____
F27 Torque boost selection	0	_____	_____
F28 Torque boost in forward direction	2%	_____	_____
F29 Torque boost in reverse direction	2%	_____	_____
F30 V/F Pattern	0	_____	_____
F31 User V/F frequency 1	12.50Hz	_____	_____
F32 User V/F voltage 1	25%	_____	_____
F33 User V/F frequency 2	25.00Hz	_____	_____
F34 User V/F voltage 2	50%	_____	_____

PARAMETER / DESCRIPTION	DEFAULT SETTINGS	SETTING 1	SETTING 2
F35 User V/F frequency 3	37.50Hz	_____	_____
F36 User V/F voltage 3	75%	_____	_____
F37 User V/F frequency 4	50.00Hz	_____	_____
F38 User V/F voltage 4	100%	_____	_____
F39 Output voltage setting	100%	_____	_____
F40 Energy saving level	0%	_____	_____
F50 Selection of Electronic thermal protection	0	_____	_____
F51 Level of Electronic thermal protection for 1 minute	150%	_____	_____
F52 Level of Electronic thermal protection for continuous	100%	_____	_____
F53 Motor cooling mode	150%	_____	_____
F54 Overload warning level	150%	_____	_____
F55 Overload warning time	10 sec	_____	_____

PARAMETER / DESCRIPTION	DEFAULT SETTINGS	SETTING 1	SETTING 2
F56 Overload trip selection	1	_____	_____
F57 Overload trip level	180%	_____	_____
F58 Overload trip time	60 sec	_____	_____
F59 Stall prevention mode	0	_____	_____
F60 Stall prevention level	150%	_____	_____
F61 Voltage limit select when stall prevention mode during decel.	0	_____	_____
F63 Save Up/Down frequency select	0	_____	_____
F64 Saved frequency in Up/Down mode	-	_____	_____
F65 Up/Down mode selection	0	_____	_____
F66 Step frequency in Up/Down mode	0.00Hz	_____	_____
F70 Draw run mode selection	0	_____	_____
F71 Output frequency variation rate in Draw mode	0.0%	_____	_____

PARAMETER / DESCRIPTION	DEFAULT SETTINGS	SETTING 1	SETTING 2
FUNCTION 2 group (H)			
H0 Parameter jump	1	_____	_____
H1 Fault history 1	nOn	_____	_____
H2 Fault history 2	nOn	_____	_____
H3 Fault history 3	nOn	_____	_____
H4 Fault history 4	nOn	_____	_____
H5 Fault history 5	nOn	_____	_____
H6 Reset fault history	0	_____	_____
H7 Dwell frequency	5.00Hz	_____	_____
H8 Dwell time	0.0 sec	_____	_____
H10 Selection of resonant frequencies	0	_____	_____
H11 Low resonant frequency range 1	10.00Hz	_____	_____
H12 High resonant frequency range 1	15.00Hz	_____	_____

PARAMETER / DESCRIPTION	DEFAULT SETTINGS	SETTING 1	SETTING 2
H13 Low resonant frequency range 2	20.00Hz	_____	_____
H14 High resonant frequency range 2	25.00Hz	_____	_____
H15 Low resonant frequency range 3	30.00Hz	_____	_____
H16 High resonant frequency range 3	35.00Hz	_____	_____
H17 S-Curve start	40%	_____	_____
H18 S-Curve end	40%	_____	_____
H19 Selection of input/output phase loss protection	0	_____	_____
H20 Restart after power supply fault	0	_____	_____
H21 Restart after fault reset	0	_____	_____
H22 Speed search function	0	_____	_____
H23 Current level for Speed search	100%	_____	_____
H24 P gain for Speed search	100	_____	_____
H25 I gain for Speed search	200	_____	_____

PARAMETER / DESCRIPTION	DEFAULT SETTINGS	SETTING 1	SETTING 2
H26 Tries of automatic fault resets (Auto-restart)	0	_____	_____
H27 Time between tries of automatic fault resets	1.0 sec	_____	_____
H30 Motor power setting	__kW	_____	_____
H31 Selection of number of motor poles	4	_____	_____
H32 Rated slip frequency	__Hz	_____	_____
H33 Motor rated current	__A	_____	_____
H34 No load motor current	__A	_____	_____
H36 Motor efficiency	__%	_____	_____
H37 Load inertia rate	0	_____	_____
H39 Setting of Carrier frequency (commutation freq.)	3kHz	_____	_____
H40 Selection of Control mode	0	_____	_____
H41 Auto-tuning of motor parameters	0	_____	_____
H42 Stator resistance (Rs)	-	_____	_____

PARAMETER / DESCRIPTION	DEFAULT VALUE	SETTING 1	SETTING 2
H44 Leakage inductance (L σ)	-	_____	_____
H45 Sensorless P gain	1000	_____	_____
H46 Sensorless I gain	100	_____	_____
H47 Sensorless torque limit	180.0%	_____	_____
H48 PWM mode selection	0	_____	_____
H49 PID control selection	0	_____	_____
H50 PID Feedback setting	0	_____	_____
H51 P gain for PID mode	300.0%	_____	_____
H52 I gain (Integral time) for PID mode	1.0 sec	_____	_____
H53 D gain (Differential time) for PID mode	0.0 sec	_____	_____
H54 PID control mode selection	0	_____	_____
H55 High limit of output frequency in PID mode	50.00Hz	_____	_____
H56 Low limit of output frequency in PID mode	0.50Hz	_____	_____

PARAMETER / DESCRIPTION	DEFAULT SETTINGS	SETTING 1	SETTING 2
H57 PID reference mode setting	0	_____	_____
H59 Output inversion in PID mode	0	_____	_____
H60 Selection of self-diagnostic	0	_____	_____
H61 Sleep delay time	60 sec	_____	_____
H62 Sleep frequency	0.0Hz	_____	_____
H63 Wake up level in Sleep mode	2%	_____	_____
H64 KEB operation selection	0	_____	_____
H65 KEB operation start level	125.0%	_____	_____
H66 KEB operation stop level	130.0%	_____	_____
H67 KEB operation gain	1000	_____	_____
H69 Frequency of accel/decel change	0Hz	_____	_____
H70 Reference frequency for accel/decel	0	_____	_____
H71 Accel/Decel time scale	1	_____	_____

PARAMETER / DESCRIPTION	DEFAULT SETTINGS	SETTING 1	SETTING 2
H72 Power on display (first screen)	0	_____	_____
H73 Selection of user screen	0	_____	_____
H74 Displaying of gain for motor rpm	100%	_____	_____
H75 Selection of operation rate limit of dynamic brake resistor	0	_____	_____
H76 Operation rate of dynamic brake resistor	10%	_____	_____
H77 Cooling fan control	0	_____	_____
H78 Selection of operation mode when cooling fan malfunctions	0	_____	_____
H79 Software Version	EU 2.x	_____	_____
H81 Accel. time for second motor	5.0 sec	_____	_____
H82 Decel. time for second motor	10.0 sec	_____	_____

PARAMETER / DESCRIPTION	DEFAULT SETTINGS	SETTING 1	SETTING 2
H83 Base frequency for second motor	50.00Hz	_____	_____
H84 V/F Pattern for second motor	0	_____	_____
H85 Forward torque boost for second motor	5%	_____	_____
H86 Reverse torque boost for second motor	5%	_____	_____
H87 Stall prevention level for second motor	150%	_____	_____
H88 Electronic thermal protection for 1 minute for second motor	150%	_____	_____
H89 Electronic thermal protection for continuous for second motor	100%	_____	_____
H90 Motor rated current for second motor	__ _A	_____	_____
H91 Parameters read	0	_____	_____
H92 Parameters write	0	_____	_____
H93 Parameters initialize	0	_____	_____
H94 Password register	0	_____	_____
H95 Parameters lock	0	_____	_____

PARAMETER / DESCRIPTION	DEFAULT SETTINGS	SETTING 1	SETTING 2
I/O group (I)			
I0 Parameter jump	1	_____	_____
I2 Minimum voltage of NV input	0.00V	_____	_____
I3 Minimum freq. for NV input at min. voltage	0.00Hz	_____	_____
I4 Maximum voltage of NV input	10.00V	_____	_____
I5 Maximum freq. for NV input at max. voltage	50.00Hz	_____	_____
I6 Filter time constant for analogue voltage of V1 input	10ms	_____	_____
I7 Minimum voltage of V1 input	0V	_____	_____
I8 Minimum freq. for V1 input at min. voltage	0.00	_____	_____
I9 Maximum voltage of V1 input	10V	_____	_____
I10 Maximum freq. for V1 input at max. voltage	50.00Hz	_____	_____
I11 Filter time constant for analogue current of I input	10ms	_____	_____
I12 Minimum current of I input	4.00mA	_____	_____

PARAMETER / DESCRIPTION	DEFAULT SETTINGS	SETTING 1	SETTING 2
I13 Minimum freq. for I input at minimum voltage	0.00Hz	_____	_____
I14 Maximum current of I input	20.00 mA	_____	_____
I15 Maximum freq. for I input at maximum voltage	50.00 Hz	_____	_____
I16 Criteria for signal loss of reference analogue input	0	_____	_____
I17 Configuration of multi-function digital input P1	0	_____	_____
I18 Configuration of multi-function digital input P2	1	_____	_____
I19 Configuration of multi-function digital input P3	2	_____	_____
I20 Configuration of multi-function digital input P4	3	_____	_____
I21 Configuration of multi-function digital input P5	4	_____	_____
I22 Configuration of multi-function digital input P6	5	_____	_____
I23 Configuration of multi-function digital input P7	6	_____	_____
I24 Configuration of multi-function digital input P8	7	_____	_____

PARAMETER / DESCRIPTION	DEFAULT SETTINGS	SETTING 1	SETTING 2
I25 Input terminals status	0	_____	_____
I26 Output terminals status	0	_____	_____
I27 Filter time constant for digital inputs	4	_____	_____
I30 Multi-step frequency 4	30.00 Hz	_____	_____
I31 Multi-step frequency 5	25.00 Hz	_____	_____
I32 Multi-step frequency 6	20.00 Hz	_____	_____
I33 Multi-step frequency 7	15.00 Hz	_____	_____
I34 Multi-accel. time 1	3.0 sec	_____	_____
I35 Multi-decel. time 1	3.0 sec	_____	_____
I36 Multi-accel. time 2	4.0 sec	_____	_____
I37 Multi-decel. time 2	4.0 sec	_____	_____
I38 Multi-accel. time 3	5.0 sec	_____	_____
I39 Multi-decel time 3	5.0 sec	_____	_____

PARAMETER / DESCRIPTION	DEFAULT SETTINGS	SETTING 1	SETTING 2
I40 Multi-accel. time 4	6.0 sec	_____	_____
I41 Multi-decel. time 4	6.0 sec	_____	_____
I42 Multi-accel. time 5	7.0 sec	_____	_____
I43 Multi-decel. time 5	7.0 sec	_____	_____
I44 Multi-accel. time 6	8.0 sec	_____	_____
I45 Multi-decel. time 6	8.0 sec	_____	_____
I46 Multi-accel. time 7	9.0 sec	_____	_____
I47 Multi-decel. time 7	9.0 sec	_____	_____
I50 Analogue output mode	0	_____	_____
I51 Analogue output setting	100%	_____	_____
I52 Level of frequency detection	30.00 Hz	_____	_____
I53 Bandwidth of frequency detection	10.00 Hz	_____	_____
I54 Multi-function output (MO) configuration	12	_____	_____

PARAMETER / DESCRIPTION	DEFAULT SETTINGS	SETTING 1	SETTING 2
I55 Multi-function relay (3A, B, C) configuration	17	_____	_____
I56 Fault relay configuration	2	_____	_____
I57 Output configuration when communication error occurs	0	_____	_____
I59 Selection of communication protocol	0	_____	_____
I60 Slave number in communication net	1	_____	_____
I61 Transmission speed in communication net	3	_____	_____
I62 Stop mode after reference signal loss	0	_____	_____
I63 Time to determine speed reference signal loss	1.0 sec	_____	_____
I64 Communication time setting	5ms	_____	_____
I65 Parity/Stop bit setting	0	_____	_____
I66 Read address register 1	5	_____	_____
I67 Read address register 2	6	_____	_____

PARAMETER / DESCRIPTION	DEFAULT SETTINGS	SETTING 1	SETTING 2
I68 Read address register 3	7	_____	_____
I69 Read address register 4	8	_____	_____
I70 Read address register 5	9	_____	_____
I71 Read address register 6	A	_____	_____
I72 Read address register 7	B	_____	_____
I73 Read address register 8	C	_____	_____
I74 Write address register 1	5	_____	_____
I75 Write address register 2	6	_____	_____
I76 Write address register 3	7	_____	_____
I77 Write address register 4	8	_____	_____
I78 Write address register 5	9	_____	_____
I79 Write address register 6	A	_____	_____
I80 Write address register 7	B	_____	_____

PARAMETER / DESCRIPTION	DEFAULT SETTINGS	SETTING 1	SETTING 2
I81 Write address register 8	C	_____	_____
I82 Brake open current	50.0%	_____	_____
I83 Brake open delay time	1.0 sec	_____	_____
I84 Brake open FX frequency	1.00Hz	_____	_____
I85 Brake open RX frequency	1.00Hz	_____	_____
I86 Brake close delay time	1.0 sec	_____	_____
I87 Brake close frequency	2.00Hz	_____	_____
I88 Fire mode frequency	50.00 Hz	_____	_____
I89 Minimum scaling factor for PID feedback	0.0	_____	_____
I90 Maximum scaling factor for PID feedback	100.0	_____	_____
I91 Selection of contact type A (NO), or B (NC) for multi-function output (MO)	0	_____	_____
I92 On delay time for multi-function output (MO)	0.0 sec	_____	_____

PARAMETER / DESCRIPTION	DEFAULT SETTINGS	SETTING 1	SETTING 2
I93 Off delay time for multi- function output (MO)	0.0 sec	_____	_____
I94 On delay time for multi- function relay (3A, B, C)	0.0 sec	_____	_____
I95 Off delay time for multi- function relay (3A, B, C)	0.0 sec	_____	_____
I96 Fire mode	-	_____	_____



24 Hours Technical Assistance 365 days a year

902 40 20 70

■ **HEAD OFFICE**

SPAIN C/ Leonardo da Vinci, 24 - 26, Parque Tecnológico - 46980 - Paterna - VALENCIA - SPAIN
 Tel. 902 40 20 70 - (+34) 96 136 65 57 - Fax. (+34) 96 131 82 01

■ **BRANCHES**

AUSTRALIA	Power Electronics Australia Pty Ltd U6, 30-34 Octal St, Yatala, BRISBANE, QUEENSLAND 4207 - P.O. Box 3166 Browns Plains - Queensland 4118 - AUSTRALIA Tel. (+61) 7 3386 1993 - Fax. (+61) 7 3386 1997	
CHILE	Power Electronics Chile Ltda Los Productores #4439 - Huechuraba SANTIAGO - CHILE Tel. (+56) (2) 244 0308 - 0327 - 0335 Fax. (+56) (2) 244 0395	Oficina Petronila # 246, Casa 19 ANTOFAGASTA - CHILE Tel. (+56) (55) 793 965
CHINA	Power Electronics Beijing Room 509, Yiheng Building No. 28 East Road, Beisanhuan 100013 - Chaoyang District BEIJING - R.P. CHINA Tel. (+86 10) 6437 9196 / 97 Fax (+86 10) 6437 9181	Power Electronics Asia Ltd 20/F Winbase Centre, 208 Queen's Road Central HONG KONG - R.P. CHINA
GERMANY	Power Electronics Deutschland GmbH Dieselstrasse, 41 - D-90441 - NÜRNBERG - GERMANY Tel. (+49) 911 99 43 99 0 - Fax (+49) 911 99 43 99 8	
INDIA	Power Electronics India No. 26, 3 rd Cross, Vishwanathapuram 625014 MADURAI - INDIA Tel. (+91) 452 434 7348 - Fax (+91) 452 434 7348	
KOREA	Power Electronics Asia HQ Co. Room #305, SK Hub Primo Building 953-1, Dokok-dong, Gangnam-gu SEOUL - 135-270 KOREA Tel. (+82) 2 3462 4656 - Fax (+82) 2 3462 4657	
MEXICO	P.E. Internacional México S de RL Luz Savifón, 205, Colonia del Valle 03100 - MEXICO DF	



www.power-electronics.com